

# Mount Isa Line

## Information Pack

Stuart to Mount Isa  
Flynn to Phosphate Hill

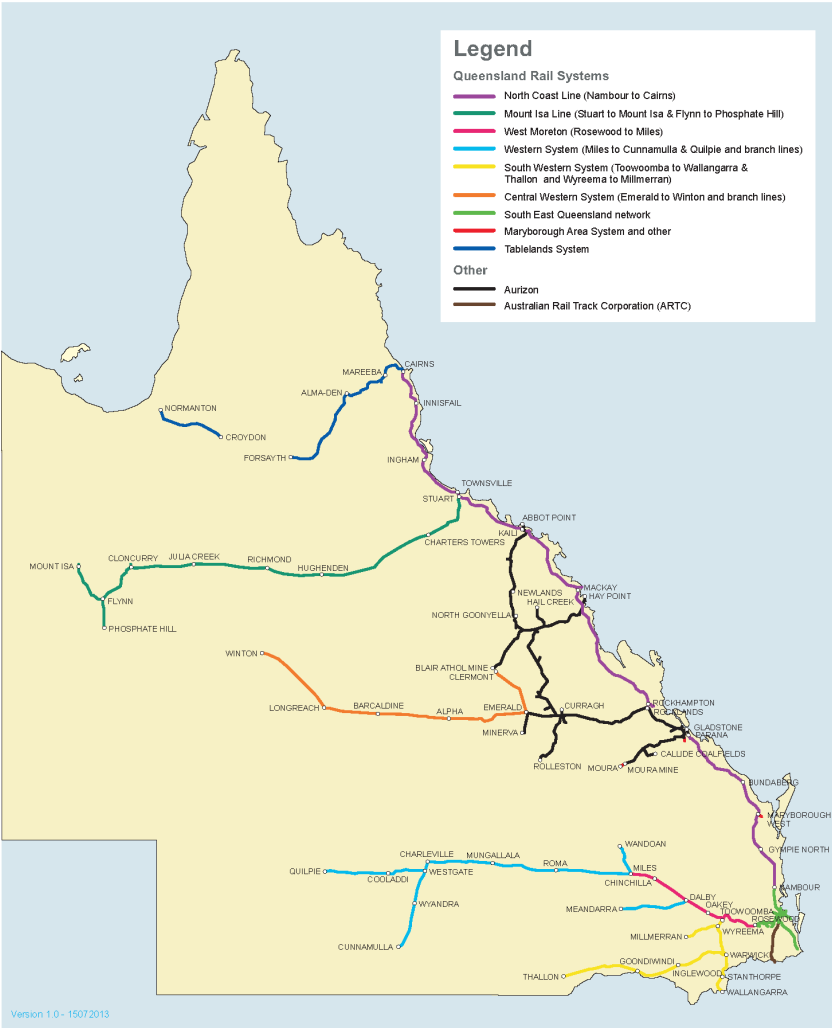

**Queensland Rail does not warrant the fitness for purpose or accuracy of this information.**

Mount Isa Line  
Information Pack

## **Version Information**

Version 4.0: 30/01/2024

- Complete review and update

Version 3.1: 20/02/2017

Queensland Rail does not warrant the fitness for purpose or accuracy of this information.

Mount Isa Line  
Information Pack

## Table of Contents

Introduction.....	4
General Information.....	6
General Climate.....	7
Temperature .....	8
Humidity.....	11
Rainfall.....	11
Cyclone.....	11
Description of the Railway.....	14
Axle Loadings.....	14
Basic Track Configuration.....	14
Stuart to Hughenden (377 km).....	14
Hughenden to Cloncurry (392 km).....	15
Cloncurry to Mount Isa (197 km).....	17
Flynn to Phosphate Hill (66 km).....	17
Description of the Track.....	18
Operational Constraints - Infrastructure.....	22
Operational Constraints - Rollingstock .....	22
Maximum Train Length.....	23
Sectional Running Times.....	23
Incident Recovery Time and Management .....	24
Rail/Road Interfaces .....	25
Rollingstock Braking Rate .....	25
The required stopping distances for the train are specified in <i>MD-10-194 Interface Standards</i> . Queensland Rail can advise which braking curve is applicable to the particular route.....	25
Trackside Detection Equipment.....	25
Dragging Equipment Detector (DED).....	25
Hot Bearing Detector (HBD) / Hot Wheel Detector (HWD).....	26
Wheel Impact Load Detector (WILD) / Overload & Imbalanced Load Detector (OILD).....	27

**Queensland Rail does not warrant the fitness for purpose or accuracy of this information.**

Mount Isa Line  
Information Pack

- Environmental Monitoring System (EMS) .....27
- Operational Systems & Train Control .....27
- Information Systems ..... 30
- Telecommunications ..... 30
- Rail Operations and the Environment ..... 31
  - Air Quality and Contamination Impacts.....32
  - Environmental Noise Management.....32
- Future Infrastructure Improvements..... 35
  - Infrastructure Improvements ..... 35
  - Capacity Enhancements..... 35
- Infrastructure Management and Access ..... 35
- APPENDIX A Definitions .....37
- APPENDIX B Schematic Layout ..... 44
- APPENDIX C Rail/Road Interface Details ..... 49
- APPENDIX D Speed Boards ..... 58
- APPENDIX E Track Data & Grade Diagrams..... 68
- APPENDIX F Sectional Running Times..... 135
- APPENDIX G Rollingstock Outlines.....137

**Queensland Rail does not warrant the fitness for purpose or accuracy of this information.**

Mount Isa Line  
Information Pack

## Introduction

The detail provided in this pack relates to infrastructure and operational information necessary to develop an Access Application. This information is indicative of the network sufficient for developing a concept. However, critical details will need to be confirmed by Queensland Rail.

It is envisaged that Access Seekers will liaise closely with Queensland Rail Limited (Queensland Rail) to formulate a detailed operation specification as part of a full access agreement negotiation. Operational parameters outlined in this pack may be varied by mutual agreement with Queensland Rail.

All Rail Transport Operators wishing to operate in Queensland require accreditation in accordance with the Rail Safety National Law (RSNL) and need to consider, including but not limited to, the following aspects of typical rail operations:

- Provisioning, stabling or stowing areas for rollingstock
- Train crewing
- Safeworking
- Training
- Route knowledge
- Environmental requirements
- Track standards
- Signalling and traction systems, standards and constraints
- Safety training
- Management of risk
- Rollingstock registration and Train authorisation
- Legal issues as contained in Queensland Rail's Access Undertaking, Access Agreements and information contained in this pack

Rail Transport Operators will be required to be accredited by Office of the National Rail Safety Regulator (ONRSR), hold an Access Agreement with Queensland Rail and meet any conditions and precedents specified in the Access Agreement prior to commencing operations.

**Queensland Rail does not warrant the fitness for purpose or accuracy of this information.**

Mount Isa Line  
Information Pack

Accreditation means an applicant has confirmed that they are able to meet the requirements to carry out rail operations. ONRSR must be satisfied that the applicant has demonstrated:

- Effective management and control of rollingstock
- Competence and capacity to manage risks to safety associated with railway operations
- Competence and capacity to implement the required safety management system and has met the legislative requirements
- Financial capacity, or public risk insurance arrangements for potential liabilities

Contact details for ONRSR are:

**Brisbane**

T. 1800 531 982

Level 7, 410 Ann Street

Brisbane QLD 4000

PO Box 3461, Rundle Mall

Adelaide SA 5000

[onrsr.com.au](https://onrsr.com.au)

Rail Transport Operators need to be aware of and comply with other general legislation, including but not limited to Workplace Health & Safety, environmental and heritage legislation.

This Information Pack is an UNCONTROLLED DOCUMENT and is provided for information purpose only. Queensland Rail does not make any representation or warranty, express or implied, as to the accuracy, suitability or completeness of the information. To the extent that any inconsistency arises between this Information Pack and the Access Agreement or Queensland Rail's Access Undertaking, the provisions of the Access Agreement and Queensland Rail's Access Undertaking shall prevail.

Queensland Rail does not warrant the fitness for purpose or accuracy of this information.

Mount Isa Line  
Information Pack

## General Information

The Mount Isa Line is located in North Queensland between latitude 19°21' S and 21°53' S and longitude 139°29' E and 146°50' E.

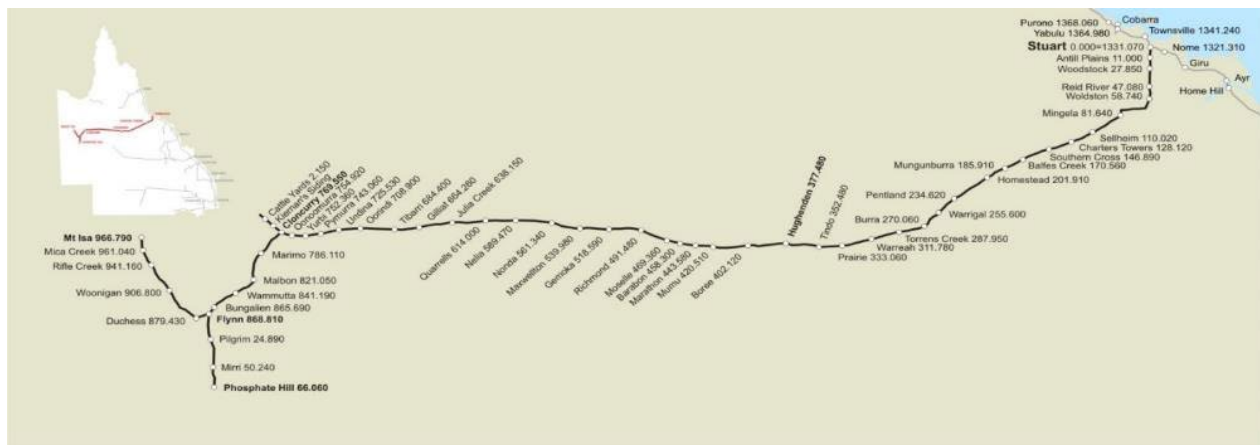

The Great Northern Railway (GNR) commences at Stuart on the North Coast Line, 10 km south of Townsville. The GNR is more commonly known as the Mount Isa Line and this term will be used for the remainder of the General Information Pack. The System is 1032 km in length (which includes the Phosphate Hill Branch). It is a single line, narrow gauge system with 46 passing loops and incorporates the balloon loops at Yurbi (privately owned), Phosphate Hill and Mount Isa (outer balloon at Mt Isa is also privately owned; only the inner balloon is open access).

The line services a number of communities along the line through passenger transport and the conveyance of general freight. The line is the critical link from the North West Minerals Province to the Port of Townsville, where the majority of bulk products are exported.

The Mount Isa Line is of particular national interest as it runs along some of the world's largest deposits of copper, lead, zinc, silver and phosphate rock. The region surrounding the Mount Isa Line produces 75% of Queensland's non-coal mineral output.

Descriptive distances within this document (unless otherwise stated) are based on physical kilometre posts in the field and are to be used only as location descriptors/chainage; they do not compensate for equalities resulting from deviations. Access charges and performance

Queensland Rail does not warrant the fitness for purpose or accuracy of this information.

Mount Isa Line  
Information Pack

statistics are generated using actual through distances derived from relevant Working Plan and Sections and reflected on Line Code Diagrams. Generally, distances originate from the junction of the branch and commence at 0 km.

## General Climate

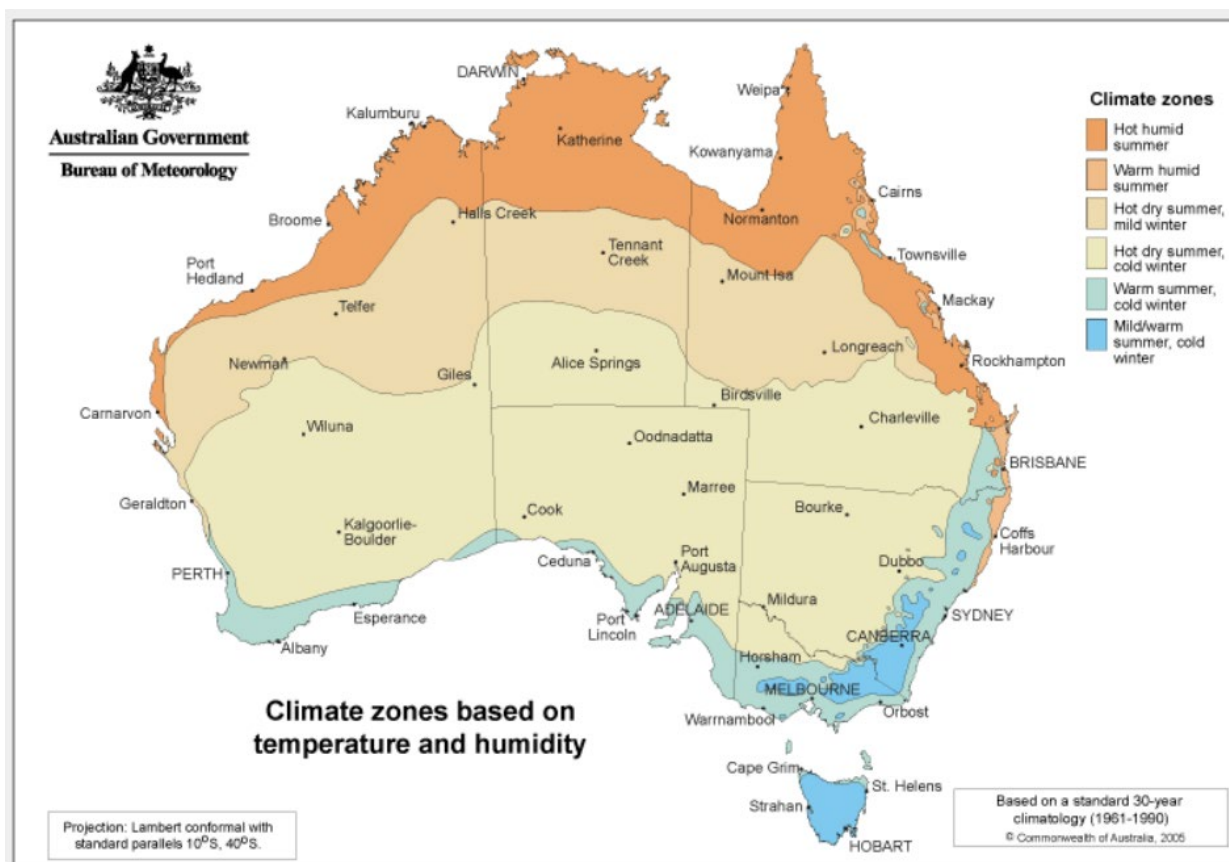

The Mount Isa Line is subject to some of the harshest weather conditions in Queensland including periods of extreme heat and flooding monsoonal rain.

With the Gulf of Carpentaria approximately 340 km to the north and the Coral Sea to the east-northeast, the Mount Isa Line experiences three main seasons:

- Mild temperatures with low humidity (May to August)
- Hot temperatures with low humidity (September to December)
- Hot temperatures with high humidity (January to April)



**Queensland Rail does not warrant the fitness for purpose or accuracy of this information.**

Mount Isa Line  
Information Pack

The following sub-sections specify general climatic parameters. For latest and more specific information potential Rail Transport Operators should consult the Australian Bureau of Meteorology at [Queensland Weather and Warnings \(bom.gov.au\)](https://www.bom.gov.au).

## Temperature

Hot days are common in inland Queensland. Although maximum temperatures can reach well into the 40°C scale in summer (45.9°C on the 29th of January 1990 the highest temperature recorded for Mount Isa), night time temperatures in Mount Isa can often be much cooler than those of nearby centres due to the significant moderating effect the higher elevation of the Northwest uplands (150 m higher) has on temperatures.

Due to the continental climate of Mount Isa, the daily temperature range is approximately 10 to 15°C throughout the year and can be as high as 20 to 25°C at times. Very low minimum temperatures can occur (lowest ever -2.9°C on the 7th of July 1984) due to the often-clear skies experienced in the winter months. Negative temperatures have occurred during the months of June, July and August.

Annual evaporation is typically much higher in inland parts of Queensland than in coastal and sub-coastal areas. Average annual pan evaporation equals or exceeds 3,000 mm in inland Queensland locations, such as Mount Isa, where average annual rainfall is typically 500 mm or less.

During periods of high temperature it may be an operational requirement to impose temporary speed restrictions – heat restrictions (reducing the train operating speed) over various sections of the track to minimise the risk of incident.

Queensland Rail does not warrant the fitness for purpose or accuracy of this information.

Mount Isa Line  
Information Pack

Average Oct to Apr max. temperature 30-year climatology (1991 to 2020)  
Australian Bureau of Meteorology

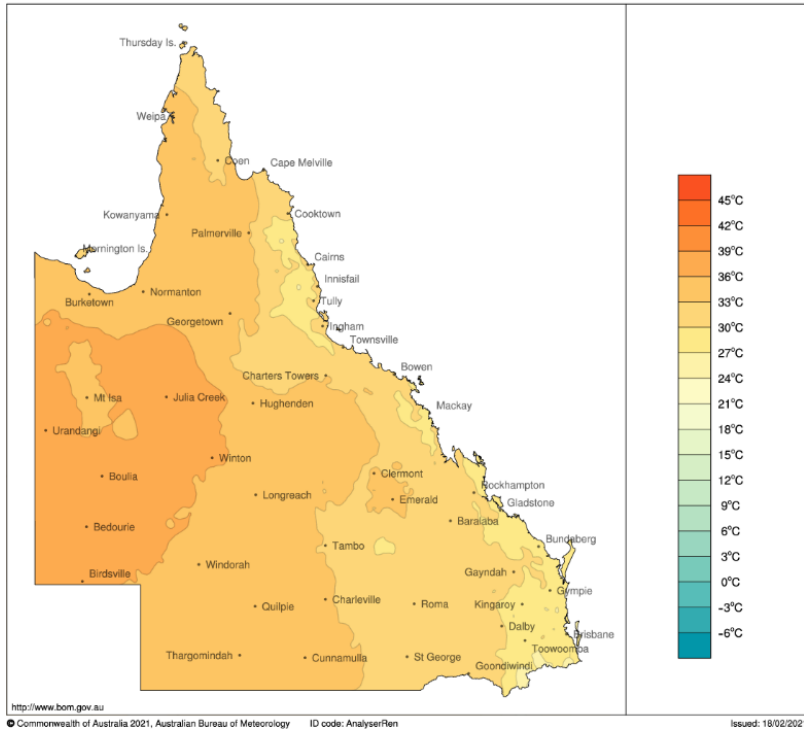

Average Apr to Oct min. temperature 30-year climatology (1991 to 2020)  
Australian Bureau of Meteorology

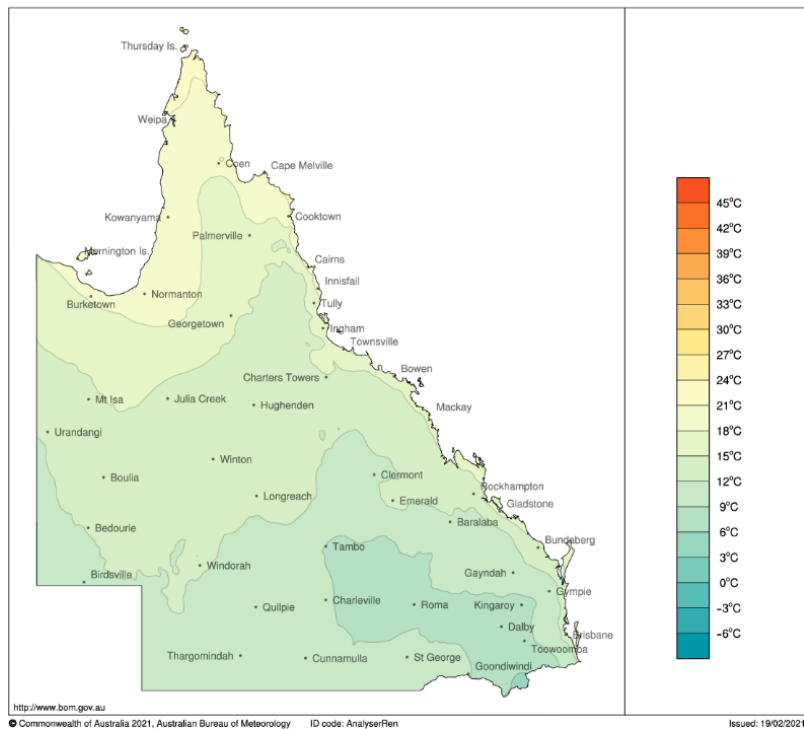

Queensland Rail does not warrant the fitness for purpose or accuracy of this information.

Mount Isa Line  
Information Pack

Highest Maximum Temperature (°C) 1 November 2022 to 31 October 2023  
Australian Bureau of Meteorology

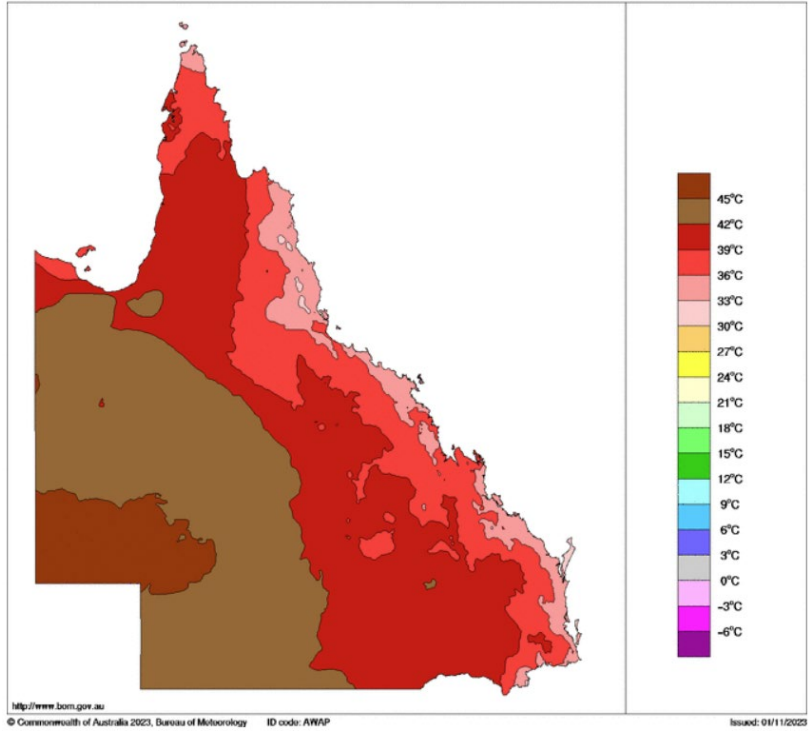

Lowest Minimum Temperature (°C) 1 November 2022 to 31 October 2023  
Australian Bureau of Meteorology

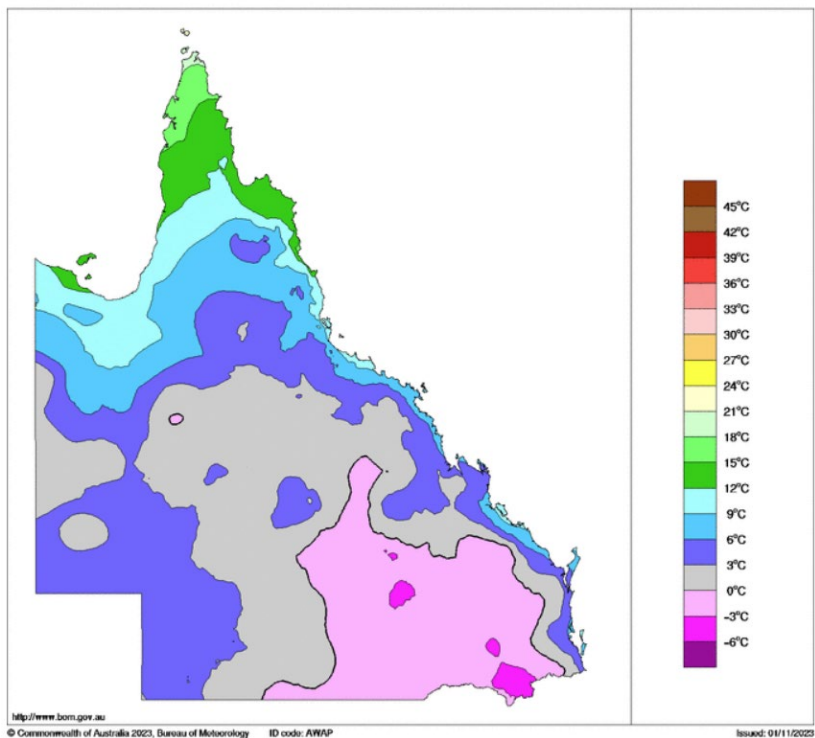

**Queensland Rail does not warrant the fitness for purpose or accuracy of this information.**

Mount Isa Line  
Information Pack

## **Humidity**

This region can experience prolonged periods of high humidity and potential Rail Transport Operators should consider this when planning/designing for rollingstock and machinery to operate on this System.

## **Rainfall**

The Mount Isa Line is built along flood plains and a portion is subject to flooding during the summer months.

Rainfall on the Mount Isa Line is mostly confined to the summer months where in excess of 75% of the annual total is usually recorded between December and March.

The district's rainfall usually comes from thunderstorms that form due to the intense heating experienced during the summer months, and from the passage of the inland trough system prevalent during the spring and summer months. Annual rainfall amounts may be less than 250 mm in one year and greater than 500 mm the following.

## **Cyclone**

Quite heavy and prolonged rain can occur with the passage of ex-tropical cyclones, which can lead to an extension south of the monsoon trough from the northern areas of Australia, or an extension inland of cyclones from the east coast. With it can come flooding of local river and stream systems, with its associated dislocation of local infrastructure.

Since 2010, Queensland has been directly impacted by 8 severe tropical cyclones and more than 20 cyclones of other intensities. In general, observations suggest there has been a rise in extreme severe weather events due to climate change and that tropical cyclones are travelling slower and southward, with increasing rainfall intensity giving rise to potentially extreme associated flooding.

Queensland Rail does not warrant the fitness for purpose or accuracy of this information.

Mount Isa Line  
Information Pack

Average January rainfall 30-year climatology (1991 to 2020)  
Australian Bureau of Meteorology

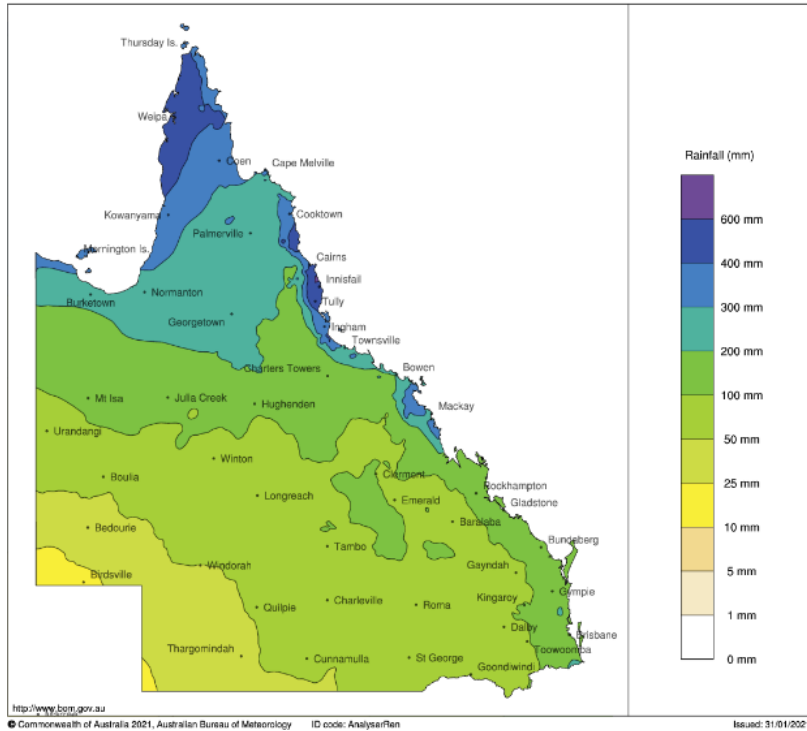

Average June rainfall 30-year climatology (1991 to 2020)  
Australian Bureau of Meteorology

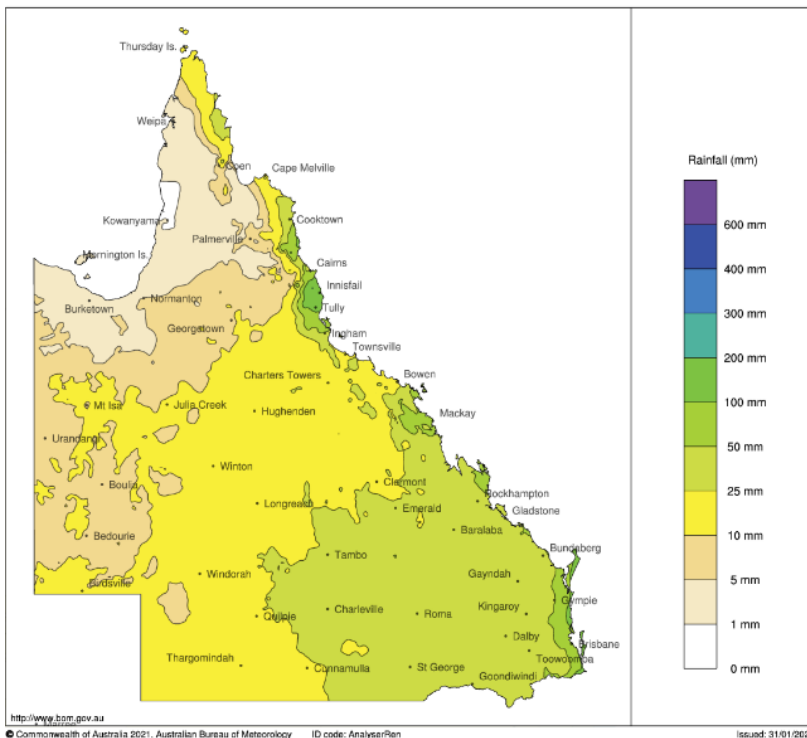

Queensland Rail does not warrant the fitness for purpose or accuracy of this information.

Mount Isa Line  
Information Pack

Queensland rainfall deciles 1 November 2019 to 31 October 2023  
Australian Gridded Climate Data

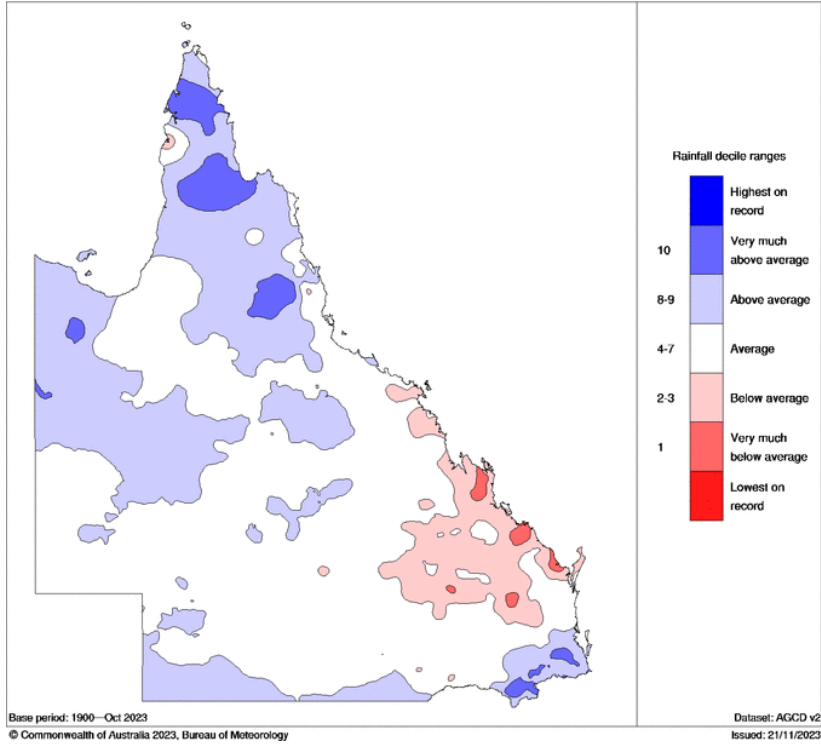

Queensland total rainfall (mm) 1 November 2022 to 31 October 2023  
Australian Gridded Climate Data

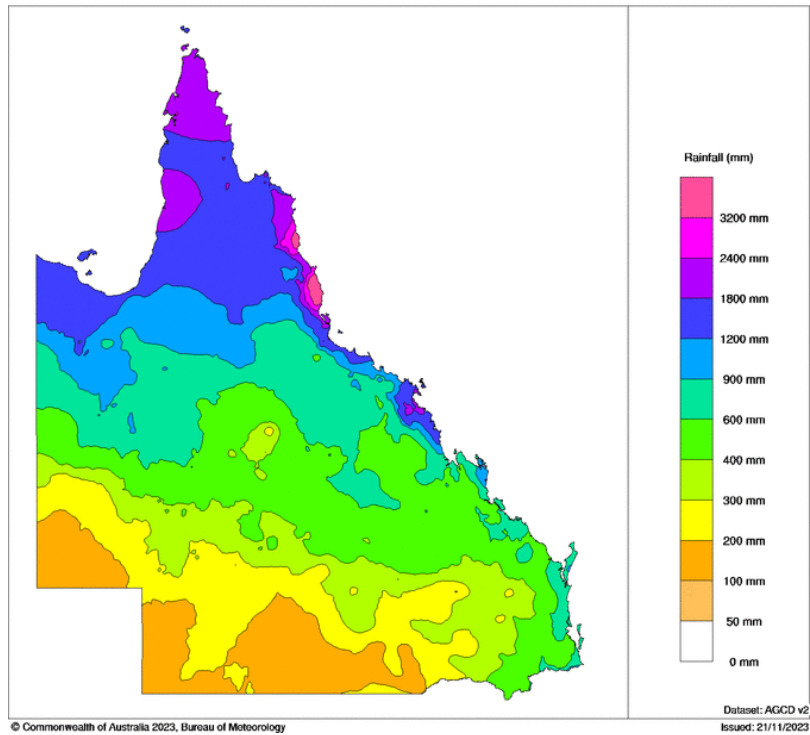

Queensland Rail does not warrant the fitness for purpose or accuracy of this information.

Mount Isa Line  
Information Pack

## Description of the Railway

<b>Total Track:</b>	1032 km single track	<b>Gauge:</b>	Narrow (1067 mm)
<b>Rail Size:</b>	41, 47, 50, 53 & 60 kg/m	<b>Axle Load:</b>	20 tal
<b>Train Control:</b>	Townsville Control Centre	<b>Safeworking:</b>	Direct Traffic Control
<b>Crossing Loops:</b>	46	<b>Balloon Loops:</b>	3
<b>Traffic:</b>	Circa 8 million gross tonne per annum	<b>Sleepers:</b>	Steel/Concrete
<b>Track Speed:</b>	80 km/hr STU-HGD	<b>Bridges:</b>	>200
	60 km/hr HGD-ISA/PHH	<b>Hot Bearing Detectors:</b>	4
<b>Weather Monitoring Stations:</b>	23	<b>Dragging Equipment Detectors:</b>	25
<b>Min Loop Length:</b>	1009 m	<b>Max Loop Length:</b>	1240 m
<b>Level Crossings:</b>	204	<b>Overload Detectors:</b>	4

### Axle Loadings

The main line and passing loops are rated at a maximum axle load of 20 t. As well as maximum load, axle spacings also need to comply with Module 2 of *MD-10-194 Interface standards*. Some sidings and/or yards may be rated at less than 20 t axle load.

### Basic Track Configuration

Basic track configuration is detailed in APPENDIX B - SCHEMATIC LAYOUT.

### Stuart to Hughenden (377 km)

The maximum grade (not compensated for horizontal alignment) that an Up train (travelling west) may encounter is 1 in 32 over a distance of 50 m between the 111-112 km whilst for a Down train (travelling east) is 1 in 35 over a distance of 100 m between the 111-112 km and 40 m between the 117-118 km.

<b>Crossing Loops</b>	<i>Antill Plains</i>	1116 m
	<i>Woodstock</i>	1105 m
	<i>Reid River</i>	1117 m
	<i>Woldston</i>	1137 m
	<i>Mingela</i>	1149 m
	<i>Sellheim</i>	1240 m
	<i>Charters Towers</i>	Yard
	<i>Southern Cross</i>	1122 m
	<i>Balfes Creek</i>	1132 m

Queensland Rail does not warrant the fitness for purpose or accuracy of this information.

Mount Isa Line  
Information Pack

	<i>Mungunburra</i>	1121 m
	<i>Homestead</i>	1129 m
	<i>Pentland</i>	1101 m
	<i>Warrigal</i>	1089 m
	<i>Burra</i>	1124 m
	<i>Torrens Creek</i>	1216 m
	<i>Warreah</i>	1126 m
	<i>Prairie</i>	1125 m
	<i>Tindo</i>	1140 m
<b>Level Crossings</b>	<i>Public</i>	40 (including flashing lights and boom gates)
	<i>Occupation</i>	43
	<i>Flashing Lights</i>	7
	<i>Boom gates</i>	2
<b>Track Structure</b>	<i>Rail Mass</i>	41, 47, 50, 53 and 60 kg
	<i>Jointed</i>	Continuously Welded Rail (CWR)
	<i>Sleeper</i>	Concrete & Steel
<b>Height and Width Restrictions</b>	<i>Max Container Height</i>	3.05 m
	<i>Max Container Width</i>	2.5 m

Existing minimum nominal horizontal curve radii are as follows:

<b>Curve Type</b>	<b>Min Nominal Radius</b>
Main Line	300 m
Crossing Loop	280 m
Sidings & Depots	140 m
Turning Angles	100 m

## Hughenden to Cloncurry (392 km)

This section of the Mount Isa Line is built along the black soil Flinders plains and is susceptible to flooding during the summer months. The black soil is relatively unstable as it swells in the wet season and contracts during the cooler winter months. The resulting track speed is limited to 60 km/h to compensate for these fluctuations.

Track structure is 41, 47, 50 and 60 kg/m rail on steel and concrete sleepers allowing 20 tal traffic travelling at a maximum speed of 80 km/h between Cloncurry and Flynn.

The maximum grade (not compensated for horizontal alignment) that an up train (travelling west) may encounter is 1 in 55 whilst for a down train (travelling east) is 1 in 50.



Queensland Rail does not warrant the fitness for purpose or accuracy of this information.

Mount Isa Line  
Information Pack

<b>Crossing Loops</b>	<i>Hughenden</i>	1075 m
	<i>Boree</i>	1096 m
	<i>Mumu</i>	1021 m
	<i>Marathon</i>	1009 m
	<i>Moselle</i>	1026 m
	<i>Richmond</i>	1191 m
	<i>Gemoka</i>	1021 m
	<i>Maxwelton</i>	1039 m
	<i>Nonda</i>	1035 m
	<i>Nelia</i>	1018 m
	<i>Quarrells</i>	1022 m
	<i>Julia Creek</i>	1024 m
	<i>Gilliat</i>	1021 m
	<i>Tibbarri</i>	1021 m
	<i>Oorindi</i>	1072 m
	<i>Undina</i>	1046 m
<i>Pymurra</i>	1020 m	
<i>Oonoomurra</i>	1033 m	
<b>Level Crossings</b>	<i>Public</i>	25 (including flashing lights)
	<i>Occupation</i>	47
	<i>Flashing Lights</i>	5
	<i>Boom gates</i>	0
<b>Track Structure</b>	<i>Rail Mass</i>	41, 47, 50, and 60 kg
	<i>Jointed</i>	Continuously Welded Rail (CWR)
	<i>Sleeper</i>	Concrete & Steel
<b>Height and Width Restrictions</b>	<i>Max Container Height</i>	3.05 m
	<i>Max Container Width</i>	2.5 m

The maximum grade (not compensated for horizontal alignment) that an Up train (travelling west) may encounter is 1 in 48 over 60 m between 487 and 488 km whilst for a Down train (travelling east) is 1 in 50 over 110 m between 486 and 487 km.

Existing minimum nominal horizontal curve radii are as follows:

<b>Curve Type</b>	<b>Min Nominal Radius</b>
Main Line	401 m
Crossing Loop	300 m
Sidings & Depots	140 m
Balloon Loop (Yurbi)	204 m

Queensland Rail does not warrant the fitness for purpose or accuracy of this information.

Mount Isa Line  
Information Pack

There is a privately owned balloon loop at Yurbi which is 47 kg/m rail on steel sleepers, with a minimum horizontal radius of 204 m and a grade of 1 in 116 against the Up train. The loop is 2.080 km in length.

## Cloncurry to Mount Isa (197 km)

The maximum grade (not compensated for horizontal alignment) that an Up train - (travelling west) may encounter is 1 in 38 over a distance of 40 m between 960 and 961 km whilst for a Down train (travelling east) is 1 in 46 (Lena Creek) between 963 and 964 km.

<b>Crossing Loops</b>	<i>Cloncurry</i>	1081 m
	<i>Marimo</i>	1024 m
	<i>Malbon</i>	1020 m
	<i>Wammutta</i>	1019 m
	<i>Bungalien</i>	1021 m
	<i>Duchess</i>	1034 m
	<i>Woonigan</i>	1063 m
	<i>Rifle Creek</i>	1021 m
<b>Level Crossings</b>	<i>Public</i>	19 (including Flashing Lights and Boom Gates)
	<i>Occupation</i>	24
	<i>Flashing Lights</i>	4
	<i>Boom gates</i>	3
<b>Track Structure</b>	<i>Rail Mass</i>	41, 47, 50 and 60 kg
	<i>Jointed</i>	Continuously Welded Rail (CWR)
	<i>Sleeper</i>	Concrete & Steel
<b>Height and Width Restrictions</b>	<i>Max Container Height</i>	3.05 m
	<i>Max Container Width</i>	2.5 m

Existing minimum nominal horizontal curve radii are as follows:

<b>Curve Type</b>	<b>Min Nominal Radius</b>
Main Line	225 m
Crossing Loop	300 m
Sidings & Depots	140 m
Balloon Loop (Mt Isa)	100 m

## Flynn to Phosphate Hill (66 km)

This single track and balloon loop carries acid and fertiliser traffic and has been constructed using 47 kg/m rail on concrete sleepers.

Queensland Rail does not warrant the fitness for purpose or accuracy of this information.

Mount Isa Line  
Information Pack

<b>Crossing Loops</b>	<i>Pilgrim</i>	1054 m
	<i>Miri</i>	1050 m
<b>Level Crossings</b>	<i>Public</i>	1
	<i>Occupation</i>	5
	<i>Flashing Lights</i>	0
	<i>Boom gates</i>	0
<b>Track Structure</b>	<i>Rail Mass</i>	47 kg
	<i>Jointed</i>	Continuously Welded Rail (CWR)
	<i>Sleeper</i>	Concrete
<b>Height and Width Restrictions</b>	<i>Max Container Height</i>	2.65 m
	<i>Max Container Width</i>	2.5 m

The maximum grade (not compensated for horizontal alignment) that an Up train (loaded - travelling south) may encounter is 1 in 125 over 340 m between 0 and 0.340 km whilst for a Down train (empty - travelling north) is 1 in 119 over 340 m between 3.020 and 3.360 km.

Existing minimum nominal horizontal curve radii are as follows:

<b>Curve Type</b>	<b>Min Nominal Radius</b>
Main Line	1200 m
Crossing Loop	300 m
Sidings & Depots	140 m
Balloon Loop (Phosphate)	204 m

## Description of the Track

Mainline track on the Mount Isa Line consists of 41, 47, 50, 53 and 60 kg/m with the associated sleeper types namely concrete and steel on crushed rock ballast. The rails are continuously welded.

Yard track on the Mount Isa Line consists of various rail sizes to suit local rail traffic tasks with the associated sleeper types of steel and timber.

The maximum permissible speeds through the divergent road of turnouts are governed by the angle of that turnout as follows:

<b>Angle of Turnout</b>	<b>Max Speed</b>
1 in 12 tangential	40 km/h
1 in 16 tangential and conventional	50 km/h
1 in 25 tangential with swing nose	80 km/h
All other turnouts	25 km/h

**Queensland Rail does not warrant the fitness for purpose or accuracy of this information.**

Mount Isa Line  
Information Pack

In general, curves (with the exception of turnout curves from the divergent road) are transitioned.

Track Data and Grade Diagrams for the major routes are included in APPENDIX E.

Queensland Rail does not warrant the fitness for purpose or accuracy of this information.

Mount Isa Line  
Information Pack



## SIMPLIFIED CURRENT NETWORK CAPABILITIES AXLE LOADS

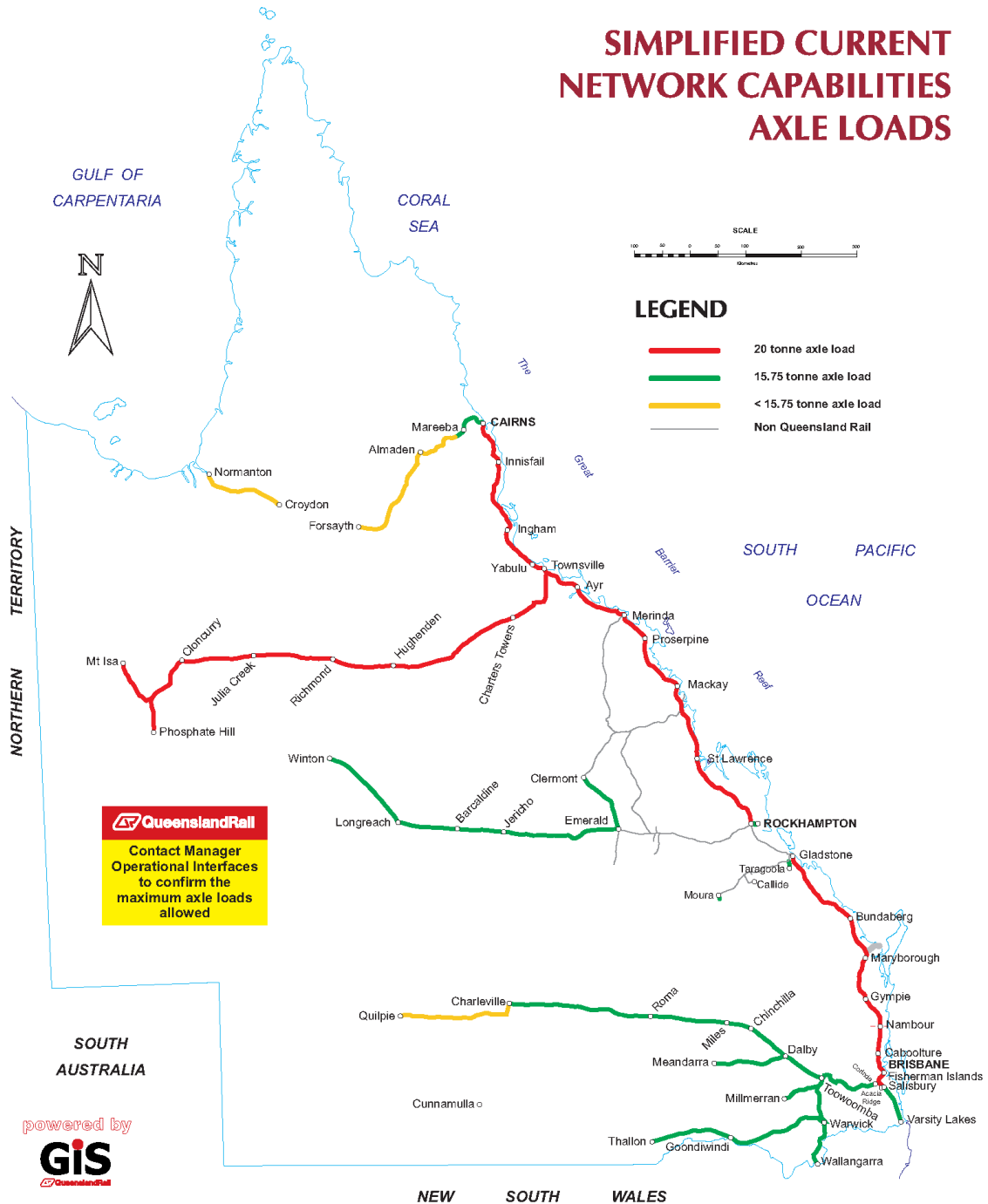

X:\\_GIS\_GRAPHICS\CORELDRAW\SIMPLIFIED CURRENT NETWORK CAPABILITIES\_AXLE\_LOADS.cdr  
Based MD-10-533 (Version 5.0)  
Last Schematic Update - 13th September 2019 10/2023 - 3



Queensland Rail does not warrant the fitness for purpose or accuracy of this information.

Mount Isa Line  
Information Pack



# SIMPLIFIED NETWORK CAPABILITIES CONTAINERS

Effective January 2020

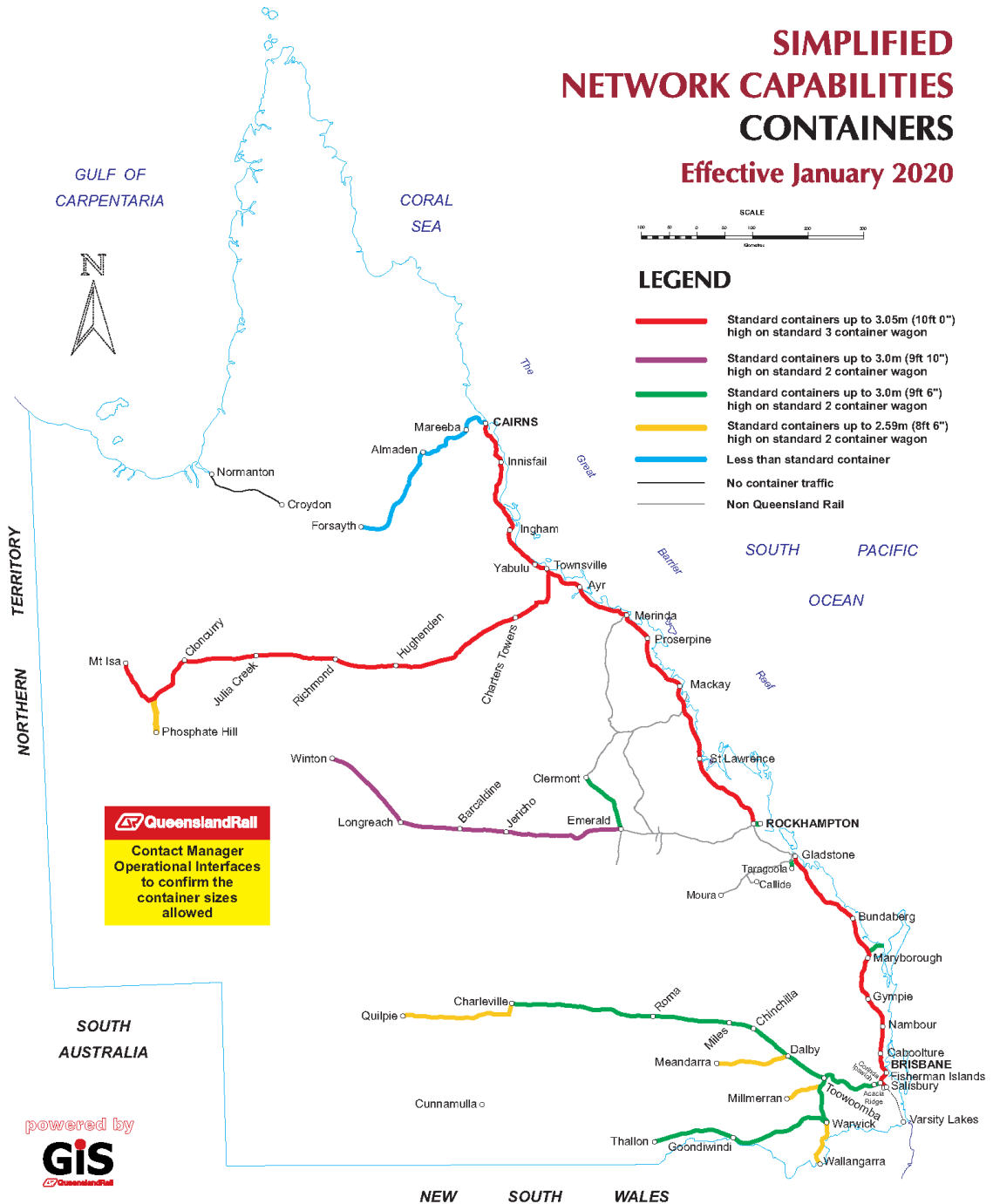

**Queensland Rail**  
Contact Manager  
Operational Interfaces  
to confirm the  
container sizes  
allowed



X:\\_GIS\_GRAPHICS\CORELDRAW\SIMPLIFIED CURRENT NETWORK CAPABILITIES\_CONTAINERS.cdr  
Last Schematic Update - 26th September 2019

10/2023 - 5



Queensland Rail does not warrant the fitness for purpose or accuracy of this information.

Mount Isa Line  
Information Pack

## Operational Constraints - Infrastructure

Queensland Rail is focused on the safety of its employees, customers and the general public. As such, Queensland Rail may impose blanket speed restrictions on the network as a precautionary measure during extreme heat in the summer months. These hot weather protocols are aimed at reducing the risk of an incident from track instability.

When the rail temperature reaches 56°C (approximately an air temperature of 37°C) a hot weather patrol will be undertaken by Queensland Rail personnel to observe and determine the condition of the track structure. On the basis of this inspection, a blanket speed restriction may be imposed if signs of track instability have been observed. All Rail Transport Operators will be informed of the speed restriction and duration of restriction by Townsville Network Control. Uniform measures for hot weather are specified in the safety standard *MD-10-143 Civil - Hot Weather Precautions for Track Stability*. A copy of this standard is available on request.

Temporary speed restrictions may also be put in place during and after the completion of maintenance activities. The extent of the restriction will depend upon the type of maintenance activity and the risk of track misalignments. All speed restrictions put in place on the network due to maintenance activities will be appropriately signed for drivers.

Force Majeure Events may also see the imposition of speed restrictions or track closures. The extent and severity of any speed restrictions are dependent on the event.

## Operational Constraints - Rollingstock

All rollingstock that operates on Queensland Rail network must be authorised by Queensland Rail. All rollingstock configurations must also be authorised by Queensland Rail.

As part of the Access Application Process, the Rail Transport Operator must demonstrate that the rollingstock has been designed, constructed, modified, appropriately tested and configured in a manner that complies with the agreed Rollingstock Interface Standards in its Interface Risk Management Plan.

*MD-10-194 Interface Standards* provides some standard outlines that are included in APPENDIX G Rollingstock Outlines herein. Queensland Rail can advise which rolling stock outline applies to a specific route. This may be one of the standard outlines in APPENDIX G or an additional outline.

**Queensland Rail does not warrant the fitness for purpose or accuracy of this information.**

Mount Isa Line  
Information Pack

## Maximum Train Length

The maximum length of trains is determined by:

- restrictions for crossing/passing other trains
- requirements for braking performance of the train
- capacity of the route
- drawgear capacity
- train handling
- requirements for road/pedestrian access across the track

Where it is necessary for a train to cross, pass or be passed by another train, the maximum train length allowable shall be such that the comparison train length (including allowance for stretching and train handling) is not longer than the crossing loop length.

The maximum train length permitted on the Mount Isa line is 1009 m. This length only applies west of Stuart. Limitations/restrictions apply between Stuart and Townsville Jetty and reduced lengths apply on other lines such as the North Coast line.

Variations of train length for a particular train configuration are possible. However, all changes need to be agreed as part of the access agreement negotiations.

## Sectional Running Times

Trains travelling west to Mount Isa are travelling in the Up Direction whilst trains travelling east to Stuart are travelling in the Down Direction. For the Flynn - Phosphate Hill section, trains travelling south to Phosphate Hill are travelling in the Up Direction whilst trains travelling north to Flynn are travelling in the Down Direction.

The sectional running times, expressed in minutes, for locomotive-hauled container trains currently operating on the Mount Isa Line are contained in APPENDIX F.

The sectional running times are “Pass to Pass” times for a running move and do not reflect acceleration and deceleration characteristics of the trains.



**Queensland Rail does not warrant the fitness for purpose or accuracy of this information.**

Mount Isa Line  
Information Pack

Proposed train configurations would need to be confirmed by the relevant operator against infrastructure constraints to determine if the sectional running times can be achieved. If the sectional running times cannot be achieved then different arrangements, including for access charges, may need to be negotiated as part of the access agreement negotiations.

Changes to the sectional running times for the System are possible over time. Any changes would need to be confirmed as part of the access agreement negotiations.

## Incident Recovery Time and Management

Incident recovery time and management is dependent on the nature, severity and location of each unique incident that may occur on the Mount Isa Line.

To enable a quick response in case of emergency, latitudes and longitudes of some passing loops where the general direction of the railway alters are detailed below:

Location	KM Point	Latitude	Longitude
Townsville Station	1340.5 km (NCL)	19° 16' S	146° 48' E
Stuart	1331.2 km (NCL)	19° 21' S	146° 50' E
Woodstock	27.850 km	19° 35' S	146° 50' E
Woldston	58.740 km	19° 83' S	146° 76' E
Charters Towers	128.120 km	20° 05' S	146° 15' E
Pentland	234.620 km	20° 31' S	145° 23' E
Torrens Creek	287.950 km	20° 46' S	145° 01' E
Prairie	333.060 km	20° 52' S	144° 35' E
Hughenden	377.480 km	20° 50' S	144° 11' E
Richmond	491.480 km	20° 44' S	143° 08' E
Julia Creek	638.150 km	20° 39' S	141° 44' E
Cloncurry	769.550 km	20° 42' S	140° 30' E
Malbon	821.050 km	21° 04' S	140° 17' E
Bungalien	865.690 km	21° 18' S	139° 59' E
Flynn	868.810 km	21° 19' S	139° 57' E
Duchess	879.430 km	21° 21' S	139° 51' E
Mount Isa	966.790 km	20° 43' S	139° 29' E
Phosphate Hill	66.060 km (PHH Branch)	21° 53' S	139° 59' E

Queensland Rail does not warrant the fitness for purpose or accuracy of this information.

Mount Isa Line  
Information Pack

## Rail/Road Interfaces

Rail Transport Operators on Mount Isa Line will encounter 204 Rail/Road Interfaces (see APPENDIX C for details) categorised as follows:

Type of Interface	No. of Interfaces
Public (Active with Flashing Light / Boom Gate Protection)	21
Public (with Passive Protection - Signs)	61
Occupation (Private Access)	122

## Rollingstock Braking Rate

The signalling system and flashing light protection at rail/road interfaces has been designed to cater for the variety of trains that currently use this System.

The required stopping distances for the train are specified in *MD-10-194 Interface Standards*. Queensland Rail can advise which braking curve is applicable to the particular route.

## Trackside Detection Equipment

Queensland Rail continues to focus on derailment prevention technologies along the Mount Isa Line. These systems provide a simultaneous alarm to the train driver and Townsville Network Control that detects problems outside normal operating parameters. These alarms indicate a potential failure, allowing intervention by train drivers and train control to reduce the risk of derailments on the line.

### Dragging Equipment Detector (DED)

Dragging Equipment Detectors (DEDs) detect anything that may be dragging underneath a train which may indicate that a wheel or wagon is derailed and provides appropriate alarms. DEDs are located at the following sites:

Location	KM Point
Toonpan	18.350
Antil Plains	22.700
Woldston	61.300

Queensland Rail does not warrant the fitness for purpose or accuracy of this information.

Mount Isa Line  
Information Pack

<b>Location</b>	<b>KM Point</b>
Eneby	92.000
Macrossan	104.800
Sellheim	110.020
Southern Cross	135.500
Thalanga	190.050
Pentland	229.300
Jardine Valley	358.000
Boree	409.000
Marathon	432.500
Barabon	452.600
Moselle	463.800
Gemoka	504.100
Quarrells	626.000
Gunjoola	648.000
Pymurra	747.080
Marimo	780.000
Mitakoodi	811.000
Wammutta	848.100
Flynn	873.000
Rifle Creek	927.360
Mica Creek	960.900
Mirri	54.100

## Hot Bearing Detector (HBD) / Hot Wheel Detector (HWD)

These devices detect faulty bearings on rollingstock that are projecting heat and noise signatures outside the normal operating parameters. On the Mount Isa Line, HBDs/HWDs are located at:

<b>Location</b>	<b>KM Point</b>
Toonpan	18.350
Thalanga	190.050
Tibarri	673.900
Rifle Creek	927.150

Queensland Rail does not warrant the fitness for purpose or accuracy of this information.

Mount Isa Line  
Information Pack

## Wheel Impact Load Detector (WILD) / Overload & Imbalanced Load Detector (OILD)

Wheel Impact Load Detectors (WILDs) identify flat wheels on rollingstock. Left undetected, these defective rollingstock wheels can cause severe damage to the network resulting in the closure of the track.

Overloaded or unevenly loaded wagons can cause excessive train and track forces that can lead to a derailment. Queensland Rail's overload and imbalanced load detectors (OILDs) are non-trade certified weigh in motion systems that measure passing wheel and axle weights and will issue alarms if the values recorded exceed set thresholds.

The WILDs/OILDs on the Mount Isa Line are located at:

Location	KM Point
Toonpan	18.350
Thalanga	190.050
Pymurra	747.080
Rifle Creek	927.150

## Environmental Monitoring System (EMS)

As part of Queensland Rail's infrastructure management system, remote Environmental Monitoring Systems (EMSes) are located at sites historically impacted by seasonal flooding. These EMSes provides critical real time information on flood (river level) and waterway flow, air temperature, rainfall gauge and rail temperature. Alerts are sent to both field staff and the Townsville Network Control as a warning for increased monitoring.

# Operational Systems & Train Control

Mount Isa Line is operated by Remote Control Signalling (RCS) between Stuart and Antill Plains and Direct Traffic Control (DTC) with Automatic Train Protection (ATP) between Antill Plains and Mount Isa / Phosphate Hill with all train movements controlled from the Townsville Network Control Centre. The Townsville Network Control Centre also controls yard movements in Charters Towers, Hughenden, Cloncurry and Mount Isa Yards by Universal Yard Control (UYC).

Queensland Rail does not warrant the fitness for purpose or accuracy of this information.

Mount Isa Line  
Information Pack

# Queensland Rail SAFeworking SYSTEMS

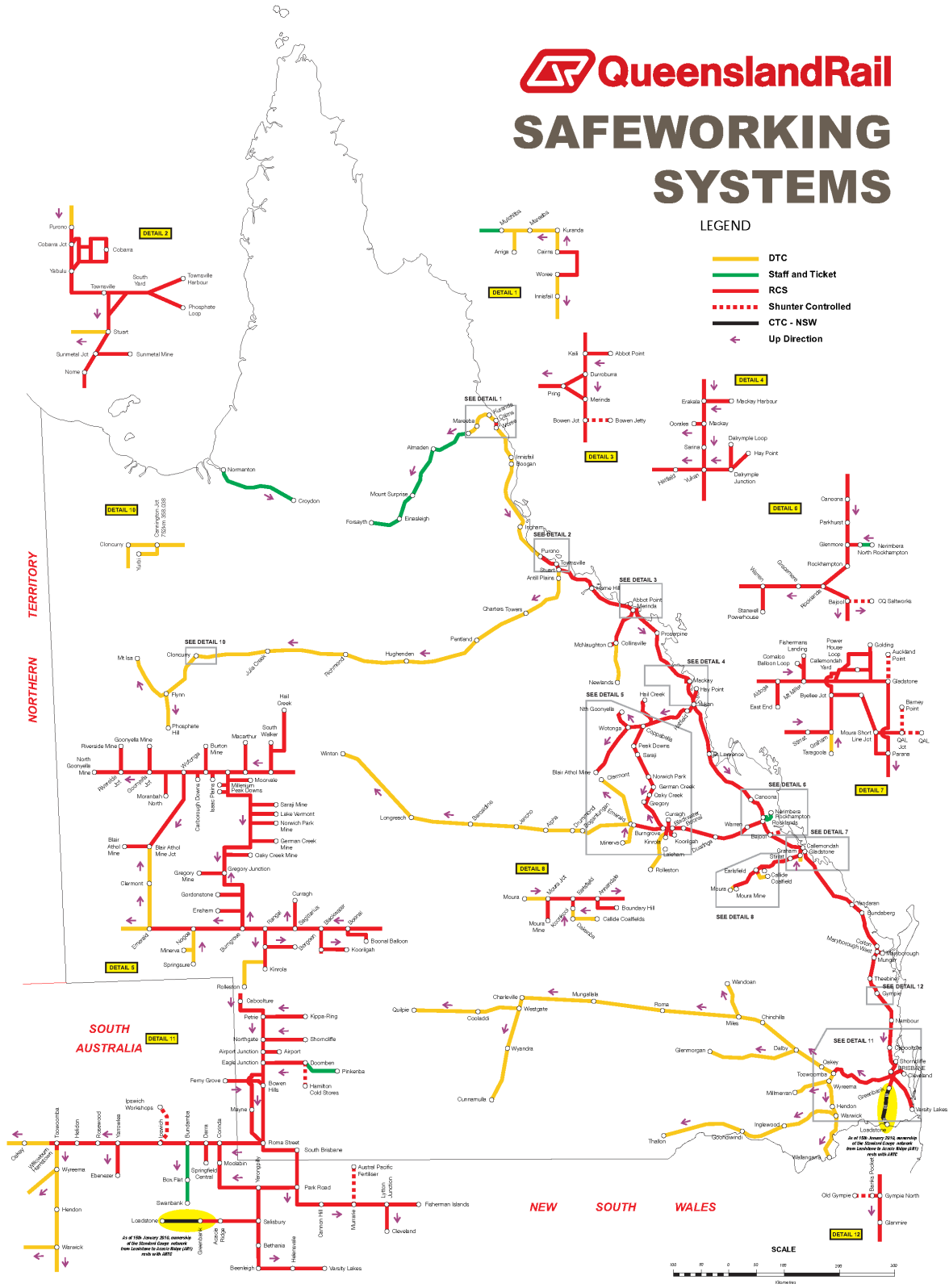

Safeworking\_QRNetwork  
(Drawing Modified - October - Kippa-Ring - RCS)

10/2023 - 19

Queensland Rail does not warrant the fitness for purpose or accuracy of this information.

Mount Isa Line  
Information Pack

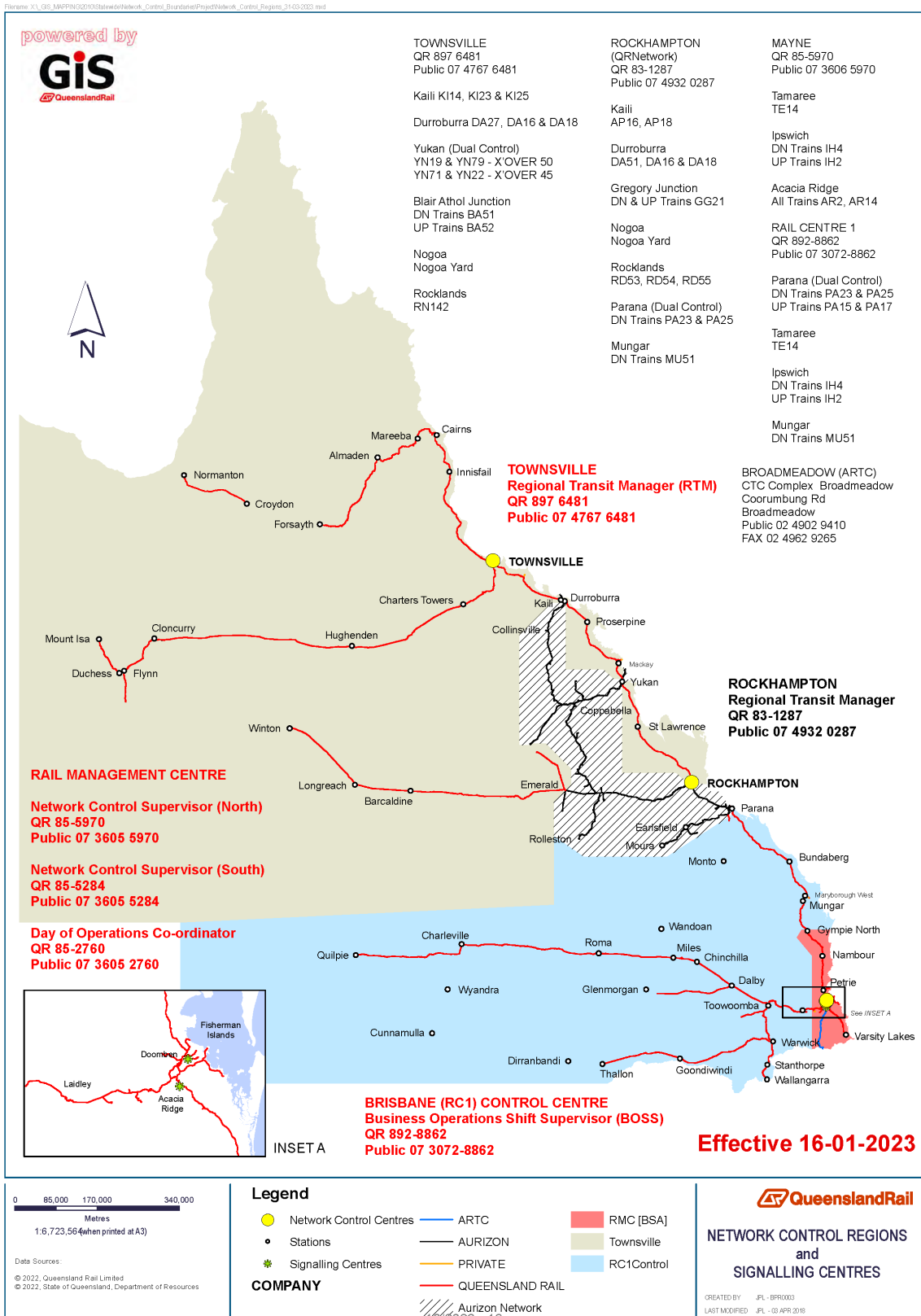

**Queensland Rail does not warrant the fitness for purpose or accuracy of this information.**

Mount Isa Line  
Information Pack

Direct Traffic Control is an electronic safeworking system used to control the movement of trains in non-signalled territory. The movement of rail traffic is governed by instructions contained in DTC Authorities issued by the Network Control Officer to rail traffic crew. DTC operates on the principle of absolute block working which provides that only one rail traffic movement will be authorised on any one block, at any one time.

## Information Systems

ViziRail is the key software system designed as a tool for use in integrated scheduling, possession planning, monitoring and reporting on the Queensland Rail network.

Functionality includes the following modules:

- Train Notices
- Train Monitoring
- Network Incident Recording
- Train Consists
- Speed Restrictions
- Planning Graphs
- Train Scheduling
- Possessions

## Telecommunications

Communications between Driver and Controller is via the QLD Rail UHF analogue radio system (Train Control Radio - TCR) or the Enhanced Radio System (ERS) (a Digital Mobile Radio (DMR) technology), which utilise a number of Queensland Rail channels and frequencies. Transceivers should utilise the “auto” setting, so that the channel or Talk Group is selected to suit the geographical location. Frequency specification and coverage details are available as part of the Access Application Process.

Access to the Maintenance Supervisory Radio System (MSR) can be gained by using Queensland Rail telephone extensions depending on location or via the UHF MSR system or ERS utilising Queensland Rail channels and frequencies.

**Queensland Rail does not warrant the fitness for purpose or accuracy of this information.**

Mount Isa Line  
Information Pack

In addition, all locomotives and other power vehicles (including Multiple Units and Miscellaneous Vehicles such as Rail Motors) must carry a second UHF radio operating on Queensland Rail Channel 150 (TX 411.375 MHz and RX 411.375 MHz). This provides on-board and wayside communications including end to end, train to train and train to track maintenance teams over an average distance of 8-10 km.

All train control and maintenance supervisory radio channels utilise mobile to base subaudio tones. No subaudible is used on Wayside channel 150.

Communications on board locomotives must conform to Queensland Rail's safety standard *MD-10-86 Telecommunications – Mobile Voice Radio Communications Systems*.

## Rail Operations and the Environment

Queensland Rail is committed to operating in a sustainable and environmentally responsible manner in support of a resilient rail network that delivers value and benefit for our customers, our people, the community and the environment. [Click here](#) to access our Environment and Sustainability Policy.

Additional Information relating to environmental management at Queensland Rail can be viewed at [Environment \(queenslandrail.com.au\)](https://www.queenslandrail.com.au/Environment).

All Rail Transport Operators operating on the Queensland Rail network are required to comply with all current state and federal legislation relating to the management and protection of the environment. Specific environmental management requirements (including noise management) are included and agreed to in all Access Agreements.

Rail Transport Operators must determine if any environmental approvals/authorities are required for the activities/operations proposed. If permits or approvals are required, they must be obtained from the relevant regulator prior to the commencement of the activities/operations. Copies of all environmental authorities administered by the Department of Environment and Science (DES) within Queensland are available upon request from DES and can be found at [environment.des.qld.gov.au](https://www.environment.des.qld.gov.au).



**Queensland Rail does not warrant the fitness for purpose or accuracy of this information.**

Mount Isa Line  
Information Pack

## **Air Quality and Contamination Impacts**

Lift off or loss of material from uncovered or unsealed wagons, or fugitive product deposits from loading can have a negative impact on local air quality values and result in contamination of the surrounding environment. This contamination can impact environmental values and cause damage to rail infrastructure.

In accordance with legislative obligations, Rail Transport Operators must take all reasonable and practicable measures to prevent the loss of product during transport on Queensland Rail's network.

## **Environmental Noise Management**

While noise from the operation of a railway is exempt from environmental nuisance provisions under the Queensland Environment Protection Act 1994, Queensland Rail strives to manage noise associated with its operations and the operations of other network users wherever reasonable and practical.

As the rail manager, Queensland Rail works closely with customers regarding environmental issues, and provides feedback to Rail Transport Operators to allow them to investigate and address as applicable, noise related issues that may be associated with their assets or operations.

There are various sources of noise from a railway and to aid efficient and effective noise reduction, a range of noise management measures are utilised by Queensland Rail. These are detailed at [queenslandrail.com.au/inthecommunity/environment/noisemanagement](https://queenslandrail.com.au/inthecommunity/environment/noisemanagement).

Rail noise and vibration requirements and criteria outlined in the Department of Transport and Main Roads (DTMR) Interim Guideline – Operational Railway Noise and Vibration (IGORNV) are applicable where a change to infrastructure or operations is likely to result in a significant change to noise impacts to nearby noise sensitive place(s). Queensland Rail will work with third-party operators to understand and support the management of these impacts.

IGORNV can be accessed via the following link:

[tmr.qld.gov.au/business-industry/Technical-standards-publications/Transport-noise-management-code-of-practice.aspx](https://tmr.qld.gov.au/business-industry/Technical-standards-publications/Transport-noise-management-code-of-practice.aspx)

Opportunities to manage/minimise rail noise must be considered as part of access planning, captured in Environmental Investigation and Risk Management Report (EIRMR) and control

**Queensland Rail does not warrant the fitness for purpose or accuracy of this information.**

Mount Isa Line  
Information Pack

measures must be discussed and agreed as part of the Interface Risk Management Plan (IRMP) development.

Where practicable, priority should be given to the management of rail noise at its source. This approach will deliver a benefit to more of Queensland Rail's neighbours than can be achieved through the delivery of fixed, last line treatments such as noise barriers. Physical noise barriers should only be considered, where suitable source-based treatments are not available.

### **Wheel Squeal & Flanging**

Wheel squeal is caused by friction forces between the top of rail and wheel interface, whereas flanging noise is predominantly caused by friction forces between the side of rail and wheel interface. Continuous or sustained wheel squeal produced primarily on the low rail side is distinct from discontinuous "flanging noise" that is produced on the high rail side. Continuous wheel squeal is of a high level, and Queensland Rail's experience is that it may cause significant community reaction, while flanging noise is of a lower level and is more accepted by the community.

Generally, tighter radius curves (i.e. under 300 metre radius), when associated with a number of rollingstock factors that promote wheel squeal, may result in squeal being produced.

Rollingstock factors that may promote wheel squeal include:

- Higher wheel hardness
- Stiff primary suspensions
- High centre plate friction
- Worn wheel treads
- Misaligned axles
- Unmatched wheel tread diameters, and
- Incorrectly adjusted side bearers

### **Noise Complaints**

Queensland Rail is committed to act towards its neighbours in a considerate and reasonable manner. This good neighbour commitment assumes a reasonable degree of tolerance from neighbours and a commitment by Queensland Rail to take action where appropriate.

Where Queensland Rail receives complaints about noise from railway activities for which Queensland Rail may be responsible, Queensland Rail responds to those complaints and maintains records of those complaints in accordance with its Safety and Environmental Management System (SEMS).

**Queensland Rail does not warrant the fitness for purpose or accuracy of this information.**

Mount Isa Line  
Information Pack

Where available, generic data will be supplied on request to a third-party operator who is proposing operations within a defined network. That data will indicate those areas where Queensland Rail has received prior complaints relating to its train operations. It will be made available when a third-party operator is undertaking the development of EIRMR as part of its Access Agreement conditions.

### **Third Party Requirements**

Any Rail Transport Operator applying for access to Queensland Rail's network shall be required to commission an environmental investigation of the proposed operations. This investigation will be conducted by a suitably qualified person, reasonably acceptable to both parties.

In response to the findings of such an investigation, the operator shall produce an Environmental Investigation and Risk Management Report (EIRMR) that identifies the risks of environmental harm associated with the operation and provides proposed controls to address the risks. This shall be reviewed by, and agreed with, Queensland Rail.

In addition, the operator shall have in place documented standards and procedures that, amongst other things, have regard for the issues, risk and control measures identified in the EIRMR. Further guidance on environmental risk investigation and management can be found in Queensland Rail's Access Undertaking.

Queensland Rail has determined that it holds no SEMS documentation that, without disclosure to a third-party operator, would either:

- Compromise or restrict a third party's operations or increase or place at risk the environmental performance of the third-party operator or itself, and
- Limit or restrict the abilities of a third-party operator to develop such documentation that would not be reasonably expected of the operator to develop on its own behalf, commensurate with the size and subsequent environmental risks of the proposed operations and the organisational resources available to it, to undertake such operations.

Any SEMS documentation (wholly or partially) identified as specifically relating to the control of corridor infrastructure (below rail) environmental issues, will be made available to the operator to assist in formulating appropriate and consistent operational (above rail) controls within their EIRMR or documented standards/procedures.

Queensland Rail does not warrant the fitness for purpose or accuracy of this information.

Mount Isa Line  
Information Pack

# Future Infrastructure Improvements

## Infrastructure Improvements

Queensland Rail has developed a planning program of works to upgrade the infrastructure of the network to increase the long-term stability of the Mount Isa Line which includes:

- replacing steel sleepers with full depth concrete sleepers; and
- replacing light rail with heavy 60kg/m rail.

Queensland Rail aims to continue the re-sleeping and re-railing to complete the transformation of the entire System. The current timing of the program is dependent on sufficient growth occurring on the line to provide the additional funding for these works. Should significant additional tonnes be contracted on the network, the works program will need to be accelerated to coincide with the increased traffic.

## Capacity Enhancements

Queensland Rail welcomes opportunities to work with customers with a view to transporting additional tonnages on this System.

We encourage Rail Transport Operators, mining companies and/or processors to engage with Queensland Rail at the earliest possible opportunity. This will allow sufficient time to work through detailed capacity analysis and to determine the network upgrades necessary and negotiate appropriate commercial arrangements.

Capacity enhancements will continue to be delivered for future projects provided that contracted tonnages:

- are sufficient to justify the necessary capital investment on commercial terms; and
- adequate notice is given from the time of contracting capacity to deliver the required enhancements.

# Infrastructure Management and Access

APPENDIX B - SCHEMATIC LAYOUT is colour coded to indicate Management of Infrastructure and Access.

**Queensland Rail does not warrant the fitness for purpose or accuracy of this information.**

Mount Isa Line  
Information Pack

Third party access to non-Queensland Rail managed infrastructure is by commercial arrangement with the relevant party.

The initial point of contact for Queensland Rail managed below rail assets is:

General Manager Commercial and Rail Access  
305 Edward Street  
Brisbane Qld 4001  
Email: [aarf.freight@qr.com.au](mailto:aarf.freight@qr.com.au)

Queensland Rail does not warrant the fitness for purpose or accuracy of this information.

Mount Isa Line  
Information Pack

# APPENDIX A Definitions

## Access Agreement

Access Agreement means an agreement between Queensland Rail and an Access Holder for the provision of Access.

## Access Undertaking

A document approved by the Queensland Competition Authority (QCA) in accordance with the QCA Act 1997 (Q) that sets out principles for negotiating access to Queensland Rail's declared services.

## Accreditation

Accreditation in accordance with Part 3 Division 4 of the Rail Safety National Law (RSNL) and "Accredited" has a similar meaning.

## ATP (Automatic Train Protection)

Automatic Train Protection is a computer-controlled system designed to make sure the train:

- does not exceed the current speed limit;
- does not exceed the limit of authority generated by the interlocking (and usually indicated by a signal at STOP);
- does not make unreasonable train movements during shunting, when stationary, or at startup

## AWS (Automatic Warning System)

Automatic Warning System is designed to

- provide an in-cab visible and audible indication of the aspect displayed in the next signal
- prompt and warn the train driver of a RESTRICTED signal aspect displayed in the next signal
- stop the train if the driver fails to acknowledge the AWS alarm of a RESTRICTED signal aspect

**Queensland Rail does not warrant the fitness for purpose or accuracy of this information.**

Mount Isa Line  
Information Pack

## **Axle Counter**

At some locations in Remote Controlled Signalling (RCS) Territory an axle counter system has been provided to detect occupancy of a section of track.

An axle counter at each end of a section determines whether an axle is entering or leaving the section and counts the number of axles passing the counter in each direction. By keeping an accurate count of axles into the section, then the number of axles out of the section, the system can determine if the section is occupied or not.

## **Block Train**

A train consisting entirely of similar classes of wagons of axle loads over 12.2 tonnes marshalled together for a certain class of traffic. The definition is also extended to cover trains in which 12 or more such wagons loaded to more than 12.2 tonnes gross per axle are included within a length of 315 metres or less of the train.

## **Comparison Train Length**

The total length in metres of a train including the locomotives. For the purpose of comparison with the length of crossing loops, it is defined as the static train length + 2% of the static train length for train handling allowance + 125mm per vehicle for coupler and drawgear tolerances.

## **Continuous Welded Rail (CWR)**

Rail that has mechanical rail joints spaced at greater than 220 m intervals or has no mechanical rail joints at all.

## **Crossing Loop Length**

The maximum length in metres of the train which can be accommodated in the loop to allow normal operation of the signalling systems for crossing or passing movements.

## **Daily Train Plan (DTP)**

Collectively, the scheduled times for all Train Services operating on Queensland Rail's Rail Infrastructure and any Planned Possession on a particular day.

**Queensland Rail does not warrant the fitness for purpose or accuracy of this information.**

Mount Isa Line  
Information Pack

## **Declared Infrastructure**

Infrastructure declared as available for access by third-party operators in accordance with the QCA Act 1997 (Q).

## **Declared Services**

Services declared as available for access by third-party operators in accordance with the QCA Act 1997 (Q).

## **Design Neutral Temperature**

The rail temperature at which the track is designed to be stress free as defined in Queensland Rail's Civil Engineering Publication CEP.26 "Rail Stressing Manual".

## **Direct Traffic Control (DTC)**

Direct Traffic Control (DTC) is an absolute block safeworking system used to control the movement of trains in non-signalled territory.

Central to DTC is an on-board DTC computer which displays authorities stored in its database. The relevant authority is activated by the train crew following an exchange of codes between the crew and the controller. Codes are exchanged verbally using the train control radio.

The procedures governing the operation of DTC are detailed in Queensland Rail's Standard *MD-10-113 Direct Traffic Control Manual*.

## **Dragging Equipment Detectors (DED)**

A mechanism positioned on sections of track to detect any dragging equipment on train.

## **Dragging Equipment Detectors Alarm (DED Alarm)**

Part of the Queensland Rail System which advises the Train Controller by a computer prompt message that a D.E.D. has been activated and the train driver by a recorded voice message.



**Queensland Rail does not warrant the fitness for purpose or accuracy of this information.**

Mount Isa Line  
Information Pack

## **Electric Train Staff**

A 'token' system of train working between interlockings on single lines in non-track-circuited areas, where release of a token is controlled by electrically connected and interlocked instruments.

## **Electromagnetic Compatibility (EMC)**

The ability of an equipment or system to function satisfactorily in its electromagnetic environment without introducing intolerable electromagnetic disturbances to anything in that environment.

## **EPP (Noise)**

Environmental Protection (Noise) Policy 2019, Subordinate Legislation to Queensland Environmental Protection Act 1994.

## **Force Majeure Event**

Means any cause, event or circumstance, or combination of causes, events or circumstances, which is beyond the reasonable control of the Party affected thereby and which by the exercise of due diligence such Party is not reasonably able to prevent or overcome, including but not limited to, results of abnormal weather conditions, act of God, breakdown of any facilities or machinery or unavailability of essential equipment, strikes or other industrial dispute.

## **Hot Wheel & Bearing Detector (HWD/HBD)**

Heat sensors located at strategic locations that identify abnormal temperatures in wheels and wheel bearings as the train passes over, transmits a signal to the train control panel that necessitates an inspection of the suspect wagon and remedial action.

## **Line Code or Line Section Code (LSC)**

Line Code is a unique alpha-numeric identifier applied to a section of track on Queensland Rail's network and usually runs from junction point to junction point. Each numeric identifier is unique and can be further rolled up into Corridors using the alpha identifier.

**Queensland Rail does not warrant the fitness for purpose or accuracy of this information.**

Mount Isa Line  
Information Pack

## **Master Train Plan (MTP)**

Collectively, the scheduled times as advised by Queensland Rail from time to time for all Train Services operating on Queensland Rail's Rail Infrastructure where such scheduled times remain unchanged from week to week, and any Planned Possessions.

## **Nominal Rail Size**

Rail sizes 20, 31 and 41 kg/m are all nominal rail sizes used to group together a range of rail types and sizes originally designated in the imperial unit "lb/yd". The term "nominal" is used in recognition of the variation in the dimensions, mass and engineering properties of the rails in this category.

## **Ordinary Staff and Ticket Working**

A token-based system of safeworking where the movement of trains on bi-directional single lines is on possession of a staff token or ticket. Each section of single line has a unique token.

## **Rail Transport Operator**

A person who has, or is seeking, Access from Queensland Rail to operate Train Services on the Rail Infrastructure and who is, or who will become Accredited in respect of those Train Services.

## **Remote Controlled Signalling (RCS)**

A system of safeworking where train movements are governed by aspects displayed in colour light signals which are controlled from a remote location and by the passage of trains. Some colour light signals and points may be released by the Train Controller to be operated from a local area by using:

- a local control panel;
- an electrically released shunting frame;
- a zone released shunting system, or
- emergency push buttons.

Rail Transport Operators' trains are expected to meet existing signalling standards to ensure track circuits and other signalling equipment operate safely and effectively. In particular, Queensland Rail's standard *MD-10-76 Signalling Principles* must be complied with.

**Queensland Rail does not warrant the fitness for purpose or accuracy of this information.**

Mount Isa Line  
Information Pack

### **Remote Train Overview Application (RTOA)**

A PC based system providing real time operational information, gathering information on train running and rail network status for immediate and continuously updated display and historical analysis.

Being a multi-tier client-server application, different levels of access/security ensure confidentiality of an Operator's train performance statistics.

### **Rollingstock Authorisation Process**

The process for determining and validating rollingstock compliance to the agreed interface standards and authorising these to be used as part of a train on the network.

### **Staff and Ticket**

The Staff and Ticket System allows for the movement of trains over a bidirectional track.

The Staff and Ticket System operates (in accordance with Queensland Rail's standard *MD-10-114 Staff and Ticket Manual*) on the principle of absolute block working, which provides that only one train will be authorised to be on any one section at any one time.

### **Standard Train**

The predominant type of train operating on the line/system.

### **Train Authorisation**

The process for acceptance of a train made up of authorised rollingstock to be operated on specified routes with stated conditions or restrictions.

### **Unit Train**

A train composed entirely of one class and one drawgear classification of rollingstock.

### **Universal Traffic Control (UTC)**

A PC based train control supervisory system that provides the means to remotely control train movements over a large area and provide management and train users with real time train related information.

**Queensland Rail does not warrant the fitness for purpose or accuracy of this information.**

Mount Isa Line  
Information Pack

## **ViziRail**

A fully integrated scheduling, possession planning, monitoring and reporting tool for managing the Queensland Rail below-rail network.

ViziRail also supports the provision of all QCA and the Department of Transport and Main Roads reporting requirements.

## **Environmental Monitoring System (EMS)**

Remote environmental monitoring systems providing critical information regarding temperature, rainfall and stream levels.

## **Wheel Impact Load Detector (WILD)**

In track monitoring system to identify wheel flats.

**Queensland Rail does not warrant the fitness for purpose or accuracy of this information.**

Mount Isa Line  
Information Pack

# APPENDIX B Schematic Layout

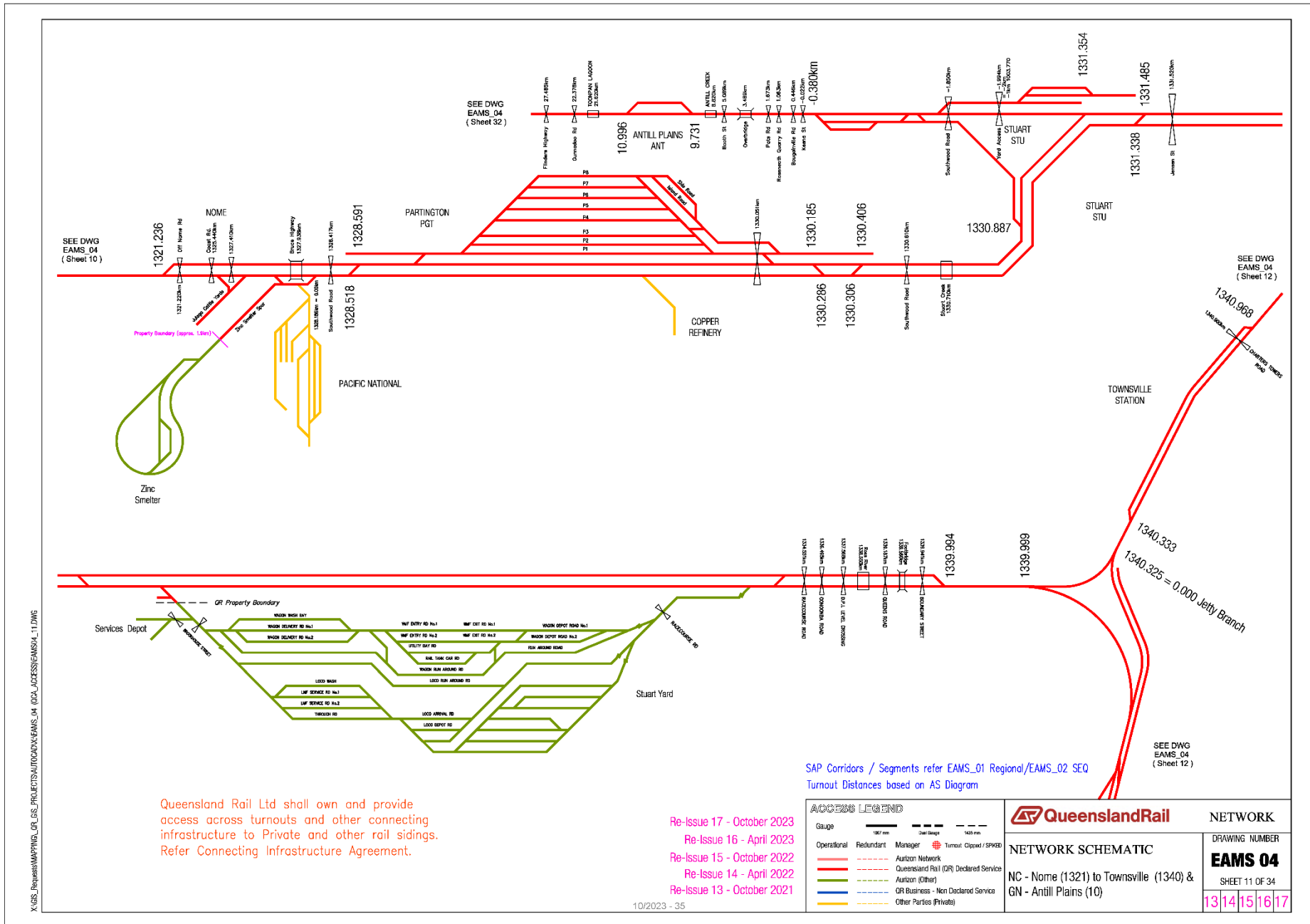



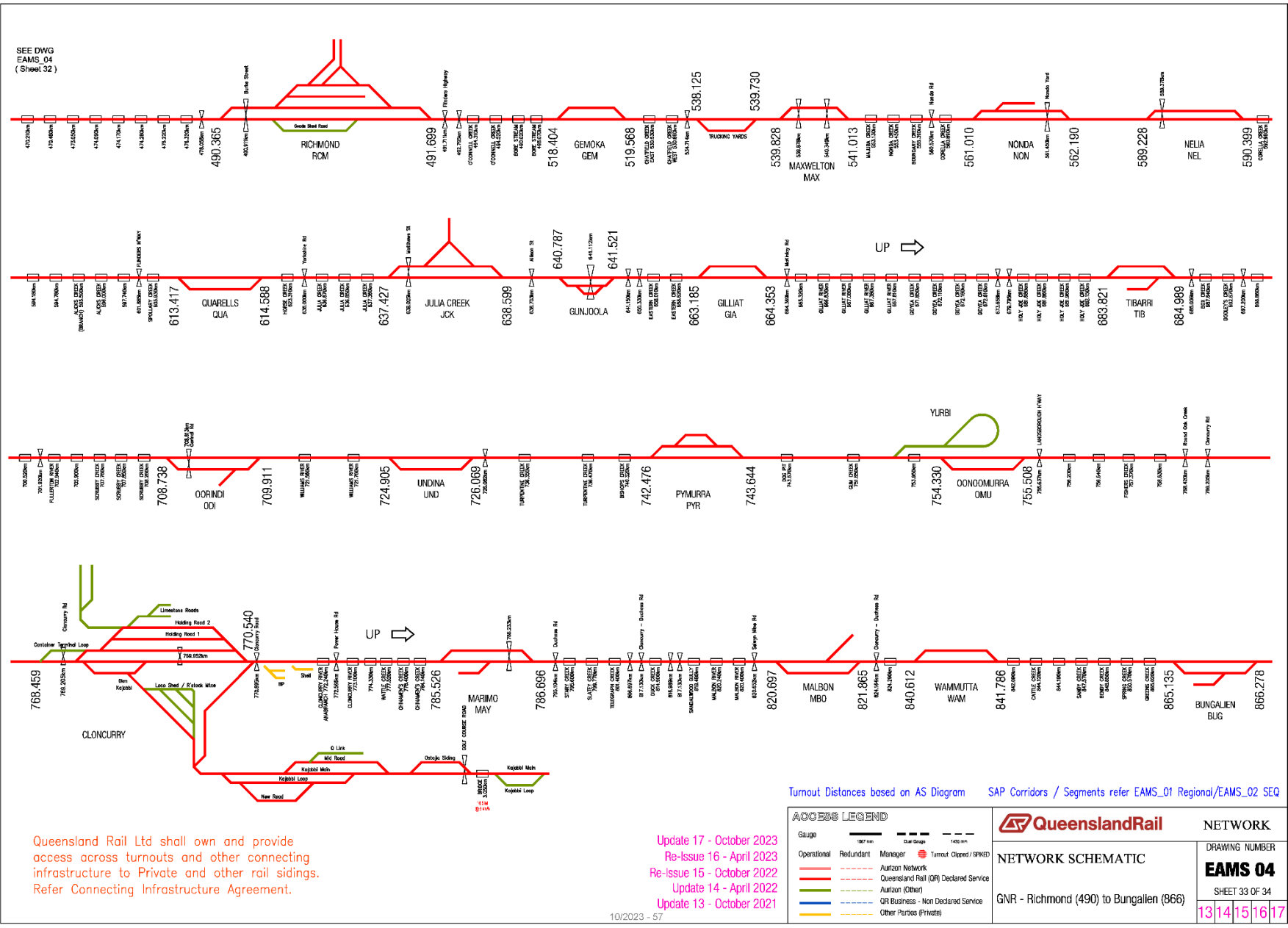





SEE DWG EAMS\_04 (Sheet 33)

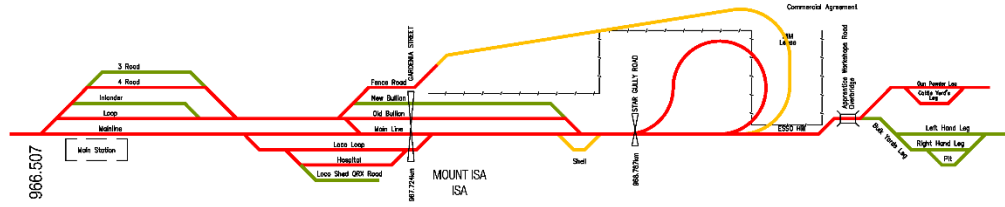

Queensland Rail Ltd shall own and provide access across turnouts and other connecting infrastructure to Private and other rail sidings. Refer Connecting Infrastructure Agreement.

X:\GIS\_Request\MAPPING\_LRP\_GIS\_PROJECTS\AUTODWG\EAMS\_04\_IDCA\_ACCESS\RAMSML\_34.DWG

Turnout Distances based on AS Diagram SAP Corridors / Segments refer EAMS\_01 Regional/EAMS\_02 SEQ

Re-Issue 17 - October 2023  
 Re-Issue 16 - April 2023  
 Re-Issue 15 - October 2022  
 Re-Issue 14 - April 2022  
 Update 13 - October 2021

10/2023 - 58

**ACCESS LEGEND**

Gauge	147 mm	152 mm	142 mm
Operational	Red Line	Red Line	Red Line
Redundant	Dashed Red Line	Dashed Red Line	Dashed Red Line
Manager	Blue Line	Blue Line	Blue Line
Turnout Clipped / SP/SD	Red Line with Red Circle	Red Line with Red Circle	Red Line with Red Circle
Aurizon Network	Red Line	Dashed Red Line	Red Line
Queensland Rail (QR) Declared Service	Red Line	Dashed Red Line	Red Line
Aurizon (Other)	Blue Line	Dashed Blue Line	Blue Line
QR Business - Non Declared Service	Blue Line	Dashed Blue Line	Blue Line
Other Parties (Private)	Yellow Line	Dashed Yellow Line	Yellow Line

<p><b>QueenslandRail</b></p> <p><b>NETWORK SCHEMATIC</b></p> <p>GNR - Flynn (868) to Mount Isa and Phosphate Hill Branch</p>	<p>NETWORK</p> <p>DRAWING NUMBER</p> <p><b>EAMS 04</b></p> <p>SHEET 34 OF 34</p>
	<p>13   14   15   16   17</p>

Queensland Rail does not warrant the fitness for purpose or accuracy of this information.

Mount Isa Line  
Information Pack

## APPENDIX C Rail/Road Interface Details

### Stuart to Mount Isa

KM	Road Name	Type	Crossing Protection
-1.979	Stuart Station Access Road (Stuart)	QR MAINTENANCE	GIVE WAY SIGNS
-1.845	Southwood Road (Stuart)	PUBLIC	HALF BOOM GATES
-0.040	Kerema Street (Stuart)	PUBLIC	SIGNS
0.450	Bougainville Street (Stuart)	PUBLIC	SIGNS
1.080	Roseneath Quarry Road (Stuart)	PUBLIC	FLASHING LIGHTS
1.680	Pats Road (Stuart)	PUBLIC	SIGNS
5.090	Booth Street (Antill Plains)	PUBLIC	FLASHING LIGHTS
22.380	Gunnado Rd	PUBLIC	SIGNS
27.490	Woodstock	PUBLIC	FLASHING LIGHTS
30.320	Ghost Gum Rd (Woodstock)	PUBLIC	SIGNS
31.820	Bidwilli Rd (Woodstock)	PUBLIC	SIGNS
34.400	Manton Quarry Road (Woodstock)	PUBLIC	SIGNS
36.720	Calcium Road (Woodstock)	PUBLIC	SIGNS
41.310	Marathon Quarry Road (Reid River)	PUBLIC	SIGNS
45.260	PineViewProperty Access(Reid River)	PRIVATE	SIGNS
48.160	Ellenvale Road (Reid River)	PUBLIC	SIGNS
56.940	Property Access Road (Woldston)	PRIVATE	SIGNS
59.230	Property Access Road (Woldston)	PRIVATE	SIGNS
64.640	Woldston - GN at 64.636	PRIVATE	SIGNS

Queensland Rail does not warrant the fitness for purpose or accuracy of this information.

Mount Isa Line  
Information Pack

KM	Road Name	Type	Crossing Protection
66.670	Woldston - GN at 66.668	PRIVATE	SIGNS
67.820	Unnamed Road (Woldston)	PRIVATE	SIGNS
73.180	Unnamed Road (Mingela)	PRIVATE	SIGNS
81.770	Mingela Road (Mingela)	PUBLIC	SIGNS
84.470	Property Access Road (Mingela)	PRIVATE	NIL
86.200	Property Access Road (Mingela)	PRIVATE	SIGNS
90.470	Heathfield Amity Road (Mingela)	PUBLIC	SIGNS
96.570	Property Access Road (Sellheim)	PRIVATE	SIGNS
104.630	Macrossan Defence Dep Rd (Sellheim)	PUBLIC	SIGNS
106.580	Fanning Downs Road (Sellheim)	PUBLIC	SIGNS
109.840	Sellheim Road (Sellheim)	PUBLIC	SIGNS
111.620	Property Access Road (Sellheim)	PRIVATE	SIGNS
114.820	GroMac Quarry Access Rd (Sellheim)	PRIVATE	SIGNS
120.950	Plum Tree Creek (Charters Towers)	PUBLIC	SIGNS
128.160	Gill Street (Charters Towers)	PUBLIC	HALF BOOM GATES
130.410	Pyrites Road (Wellington Yards)	PUBLIC	SIGNS
131.370	Chloride Street (Wellington Yards)	PUBLIC	SIGNS
133.750	KnuthsRd(BlackJackRd)(WellingtonYd)	PUBLIC	SIGNS
139.580	Flinders Highway (Southern Cross)	PUBLIC	FLASHING LIGHTS
143.650	Red Bluff Property (Southern Cross)	PRIVATE	SIGNS
144.960	Severn Vale Road (Southern Cross)	PUBLIC	SIGNS
148.010	Kapunda Road (Southern Cross)	PUBLIC	SIGNS
152.380	Ulgula Road (Southern Cross)	PUBLIC	SIGNS
160.280	Powlathanga Stn (Charters Towers)	PRIVATE	SIGNS
169.680	Lakeview Road (Balfes Creek)	PRIVATE	SIGNS

Queensland Rail does not warrant the fitness for purpose or accuracy of this information.

Mount Isa Line  
Information Pack

KM	Road Name	Type	Crossing Protection
170.780	Balfes Creek Road (Balfes Creek)	PUBLIC	SIGNS
171.555	Balfes Creek Road Balfes Creek	PRIVATE	SIGNS
182.020	Property Access Road (Mungunburra)	PRIVATE	SIGNS
186.030	Mungunburra Yard Road (Mungunburra)	PRIVATE	SIGNS
190.980	Thalanga Mine Access Rd (Thalanga)	PUBLIC	FLASHING LIGHTS
194.150	Property Access Road (Thalanga)	PRIVATE	SIGNS
199.860	Road (Homestead)	PRIVATE	SIGNS
201.610	Homestead Road (Homestead)	PUBLIC	SIGNS
215.490	Road (Homestead)	PRIVATE	SIGNS
224.490	Property Access Road (Pentland)	PRIVATE	SIGNS
225.830	Glen Houghton Road (Pentland)	PUBLIC	SIGNS
232.790	Brook Dale Road (Pentland)	PRIVATE	SIGNS
234.160	Paterson Street (Pentland)	PUBLIC	NIL
234.490	Paterson St (Pentland)	PUBLIC	SIGNS
236.010	Emergency Road (Pentland)	EMERGENCY USE	SIGNS
239.770	Property Access Road (Pentland)	PRIVATE	SIGNS
252.660	Pentland - GN at 252.664	PRIVATE	SIGNS
255.230	Pentland - GN at 255.227	PRIVATE	SIGNS
262.110	Burra Range Access 262.11 (Burra)	QR MAINTENANCE	NIL
262.530	Burra Range Access 262.529 (Burra)	QR MAINTENANCE	NIL
265.000	Burra Range Access 264.995 (Burra)	QR MAINTENANCE	NIL
268.970	Property Access (Burra)	PRIVATE	SIGNS
276.850	Denna Access Road (Burra)	PRIVATE	SIGNS
286.500	Hazel Rig-ElvaValeRd(Torrens Creek)	PUBLIC	SIGNS
288.500	Aramac-Torrens Ck Rd(Torrens Creek)	PUBLIC	SIGNS

Queensland Rail does not warrant the fitness for purpose or accuracy of this information.

Mount Isa Line  
Information Pack

KM	Road Name	Type	Crossing Protection
302.770	Property Access Rd(Torrens Creek)	PRIVATE	SIGNS
309.010	Warreah - GN at 309.012	PRIVATE	SIGNS
311.240	Penrice Stn Access Rd (Warreah)	PRIVATE	SIGNS
320.430	Warreah - GN at 320.431	PRIVATE	SIGNS
330.690	Prairie - GN at 330.689	PRIVATE	SIGNS
332.830	Prairie - Muttaborra Road (Prairie)	PUBLIC	SIGNS
334.130	Property Access Road (Prairie)	PRIVATE	SIGNS
341.680	Property Access Road (Prairie)	PRIVATE	SIGNS
348.610	Ellington Road (Tindo)	PRIVATE	SIGNS
356.370	Monavale Property Access Rd (Tindo)	PRIVATE	SIGNS
362.600	Flinders Highway (Tindo)	PUBLIC	FLASHING LIGHTS
368.590	Property Access Road (Hughenden)	PRIVATE	SIGNS
372.560	Property Access Road (Hughenden)	PRIVATE	SIGNS
375.080	Flinders Highway (Hughenden West)	PUBLIC	FLASHING LIGHTS
375.760	Road (Hughenden)	PUBLIC	SIGNS
376.870	Flinders Street (Hughenden)	PUBLIC	SIGNS
377.090	Gray Street (Hughenden)	PUBLIC	FLASHING LIGHTS
378.510	Hughenden Bypass Access (Hughenden)	PUBLIC	SIGNS
378.920	Kennedy D'mental Rd(Hughenden West)	PUBLIC	SIGNS
381.010	Hughenden - GN at 381.009	PRIVATE	SIGNS
383.990	Private Access Road (Hughenden)	PRIVATE	SIGNS
390.800	Property Access Road (Hughenden)	PRIVATE	SIGNS
397.290	Property Access Road (Boree)	PRIVATE	SIGNS
399.420	Property Access Road (Boree)	PRIVATE	SIGNS
400.650	Property Access Road (Boree)	PRIVATE	SIGNS

Queensland Rail does not warrant the fitness for purpose or accuracy of this information.

Mount Isa Line  
Information Pack

KM	Road Name	Type	Crossing Protection
404.560	Property Access Raod (Boree)	PRIVATE	SIGNS
409.360	Boree - GN at 409.359	PRIVATE	SIGNS
413.480	Dunluce Station Access Road (Mumu)	PRIVATE	SIGNS
416.870	Mumu - GN at 416.867	PRIVATE	SIGNS
425.150	Access To Thornhill Station (Mumu)	PRIVATE	SIGNS
431.460	Nindi Road (Mumu)	PRIVATE	SIGNS
443.900	Marathon Stamford Road (Marathon)	PUBLIC	SIGNS
448.660	Property Access Road (Marathon)	PRIVATE	SIGNS
452.260	Telstra Tower Access (Marathon)	PRIVATE	SIGNS
458.200	Barabon - Arjuna Road (Barabon)	PUBLIC	SIGNS
459.620	Property Access Road (Barabon)	PRIVATE	SIGNS
468.320	Property Access Road (Moselle)	PRIVATE	SIGNS
469.250	Moselle - GN at 469.25	PRIVATE	SIGNS
478.060	Wilburra Downs Stn Access (Moselle)	PRIVATE	SIGNS
486.380	Benean Stn Access Rd (Richmond)	PRIVATE	SIGNS
489.300	Allaru Stn Access Rd (Richmond)	PRIVATE	SIGNS
490.920	Burke Street (Richmond)	PUBLIC	SIGNS
491.710	Flinders Highway (Richmond)	PUBLIC	FLASHING LIGHTS
492.800	Pattel Drive (Richmond)	PUBLIC	SIGNS
496.710	Richmond - GN at 496.71	PRIVATE	SIGNS
502.090	Lonesome Dove Road (Richmond)	PRIVATE	SIGNS
509.930	Property Access Road (Richmond)	PRIVATE	SIGNS
518.400	Property Access Road (Gemoka)	PRIVATE	SIGNS
523.720	Gemoka - GN at 523.72	PRIVATE	SIGNS
530.420	Chatfield Ck Access (Maxwelton)	PRIVATE	SIGNS

Queensland Rail does not warrant the fitness for purpose or accuracy of this information.

Mount Isa Line  
Information Pack

KM	Road Name	Type	Crossing Protection
534.710	Hopevale Access Road (Maxwelton)	PRIVATE	SIGNS
539.880	Maxwelton Stn Yd East 1 (Maxwelton)	PUBLIC	SIGNS
540.350	Maxwelton Stn Yd West 2 (Maxwelton)	PUBLIC	SIGNS
550.990	Property Access Road (Maxwelton)	PRIVATE	SIGNS
560.570	Nonda Road (Nonda)	PUBLIC	SIGNS
561.450	Nonda Yard Access Road (Nonda)	QR MAINTENANCE	SIGNS
568.540	Property Access Road (Nonda)	PRIVATE	SIGNS
579.020	Nonda West Road (Nonda)	PRIVATE	SIGNS
589.380	Nelia - Bunda Road (Nelia)	PUBLIC	SIGNS
601.870	Flinders Highway (Quarrells)	PUBLIC	FLASHING LIGHTS
612.760	Quarrells - GN at 612.762	PRIVATE	SIGNS
621.680	Quarrells - GN at 621.68	PRIVATE	SIGNS
636.000	Yorkshire Road (Julia Creek)	PUBLIC	SIGNS
638.030	Matthews Street (Julia Creek)	PUBLIC	SIGNS
638.250	Goods Shed Access Rd (Julia Creek)	QR MAINTENANCE	NIL
638.700	Julia Creek-KynunaRd (Julia Creek)	PUBLIC	SIGNS
640.570	Airport Road (Gunjoola)	PUBLIC	SIGNS
650.350	Property Access Road (Gunjoola)	PRIVATE	SIGNS
664.380	McKinlay Road (Gilliat)	PUBLIC	SIGNS
673.680	Property Access Road (Gilliat)	PRIVATE	SIGNS
679.800	Ivellen Road (Tibarri)	PUBLIC	SIGNS
680.790	Property Access Road (Tibarri)	PRIVATE	SIGNS
681.910	Holey Joe Ck Access (Tibarri)	PRIVATE	NIL
685.040	Tibarri Yd Access (Tibarri)	PRIVATE	SIGNS
690.120	Private Access Road (Tibarri)	PRIVATE	SIGNS

Queensland Rail does not warrant the fitness for purpose or accuracy of this information.

Mount Isa Line  
Information Pack

KM	Road Name	Type	Crossing Protection
697.200	Bookin Road (Oorindi)	PRIVATE	SIGNS
702.020	GREAT NORTHERN LINE 702.02	PRIVATE	NIL
707.170	GREAT NORTHERN LINE 707.17	PRIVATE	NIL
708.810	Oorindi Road (Oorindi)	PUBLIC	SIGNS
726.070	Property Access Road (Undina)	PRIVATE	NIL
742.370	Property Access Road (Pymurra)	PRIVATE	SIGNS
745.230	Pymurra - GN at 745.233	PRIVATE	SIGNS
748.780	Property Access Road (Pymurra)	PRIVATE	SIGNS
755.640	Landsborough Highway (Oonoomurra)	PUBLIC	FLASHING LIGHTS
768.430	Round Oak Road (Cloncurry)	PUBLIC	FLASHING LIGHTS
769.370	Container Terminal (Cloncurry)	PRIVATE	SIGNS
770.890	Property Access Road (Cloncurry)	PRIVATE	SIGNS
772.570	Power House Road (Cloncurry)	PUBLIC	SIGNS
786.230	Property Access Road (Marimo)	PRIVATE	SIGNS
795.100	Cloncurry Dajarra Road (Marimo)	PUBLIC	SIGNS
800.700	Malbon - GN at 800.699	PRIVATE	SIGNS
806.710	Road (Malbon)	PRIVATE	SIGNS
810.700	Malbon - GN at 810.695	PRIVATE	SIGNS
816.990	Cloncurry-Duchess Road (Malbon)	PUBLIC	HALF BOOM GATES
820.650	Selwyn Mine Road (Malbon)	PUBLIC	SIGNS
824.160	Cloncurry Duchess Rd (Malbon)	PUBLIC	HALF BOOM GATES
831.170	Property Access Road (Malbon)	PRIVATE	SIGNS
835.140	Malbon - GN at 835.137	PRIVATE	SIGNS
845.640	Property Access Road (Wammutta)	PRIVATE	SIGNS
853.460	Wammutta - GN at 853.46	PRIVATE	SIGNS



Queensland Rail does not warrant the fitness for purpose or accuracy of this information.

Mount Isa Line  
Information Pack

KM	Road Name	Type	Crossing Protection
878.670	Cloncurry-Duchess Road (Duchess)	PUBLIC	SIGNS
879.710	Duchess Road (Duchess)	PUBLIC	SIGNS
890.300	Property Access Road (Duchess)	PRIVATE	SIGNS
894.160	Myubee Siding Access Road (Duchess)	QR MAINTENANCE	SIGNS
898.790	Bushy Park Road (Woonigan)	PRIVATE	SIGNS
907.180	Woonigan Yd Access Rd (Woonigan)	PRIVATE	SIGNS
924.650	Property Access Road (Rifle Creek)	PRIVATE	SIGNS
928.680	Duchess / Mt Isa Road (Rifle Creek)	PUBLIC	SIGNS
941.710	Property Access Road (Rifle Creek)	PRIVATE	SIGNS
946.320	Property Access Road (Rifle Creek)	PRIVATE	SIGNS
951.900	Property Access Road (Mica Creek)	PRIVATE	NIL
956.380	Property Access Road (Mount Isa)	PRIVATE	SIGNS
961.570	Old Mica Creek Road (Mica Creek)	PUBLIC	SIGNS
964.760	Twenty-Third Avenue (Mount Isa)	PUBLIC	FLASHING LIGHTS
965.740	Mine Barracks Access Rd (Mount Isa)	PUBLIC	SIGNS
966.180	Camphor Street (Mount Isa)	PUBLIC	FLASHING LIGHTS
966.460	Smelter Gates Crossing (Mount Isa)	PUBLIC	FLASHING LIGHTS
967.800	Gardenia Street (Mount Isa)	PUBLIC	HALF BOOM GATES
968.790	Stargully Road (Mount Isa)	PUBLIC	SIGNS
969.230	QR Maintenance Road (Mount Isa)	QR MAINTENANCE	SIGNS
969.340	Mtce Rd(Zinc Balloon)(Mount Isa)	QR MAINTENANCE	SIGNS
969.440	Mtce Rd (Inner Balloon)(Mount Isa)	QR MAINTENANCE	NIL
971.540	Haul Rd (On Container Yd Left Leg)	PRIVATE	SIGNS
971.550	Haul Rd (On Container Yd Right Leg)	PRIVATE	SIGNS

Queensland Rail does not warrant the fitness for purpose or accuracy of this information.

Mount Isa Line  
Information Pack

## Kajabbi Branch

KM	Road Name	Type	Crossing Protection
0.89	Douglas Street (Cloncurry Yard)	PUBLIC	SIGNS
1.11	McIlwraith Street (Cloncurry)	PUBLIC	FLASHING LIGHTS
2.03	Emergency Access Rd (Cloncurry Yd)	EMERGENCY USE	SIGNS
2.92	Golf Club Road (Cloncurry Yard)	PUBLIC	SIGNS
3.39	Aerodrome Road (Cloncurry Yard)	PUBLIC	SIGNS

## Phosphate Hill Branch

KM	Road Name	Type	Crossing Protection
5.550	Cloncurry-Duchess Road (Flynn)	PUBLIC	SIGNS
10.830	Property Access Road(Flynn-Pilgrim)	PRIVATE	SIGNS
22.085	Property Access Rd (Pilgrim)	PRIVATE	SIGNS
27.860	Bungalien - PH at 27.86	PRIVATE	SIGNS
49.450	Property Access Road (Mirri)	PRIVATE	SIGNS
61.360	Osborne Mine (Phosphate Hill)	PRIVATE	SIGNS

Queensland Rail does not warrant the fitness for purpose or accuracy of this information.

Mount Isa Line  
Information Pack

## APPENDIX D Speed Boards

<b>Corridor</b>	<b>KM Point</b>	<b>Speed Board</b>
<i>TRK C188 DMN Stuart - Hughenden</i> <i>TRK C188 MNL Stuart - Hughenden</i>	376.428	25
	-2.205	50
	-2.057	50
	-1.671	50/70
	-1.076	70
	-0.761	70
	-0.093	80
	58.041	25/80
	59.307	25
	59.385	25/80
	77.917	60
	103.803	80
	105.197	80
	105.877	80
	112.102	80
	112.399	80
	127.841	25
	134.431	80
	136.395	80
	137.422	80
	138.136	80
	139.106	80
	139.632	80
	140.938	80
	141.212	80
	146.609	25
	147.769	25
	183.935	80
	184.094	80
	185.166	80
	185.337	25
	201.582	25
201.673	25	
202.764	25	
233.291	60	
311.185	25	
312.339	25	
374.800	25/50	
375.223	25	

Queensland Rail does not warrant the fitness for purpose or accuracy of this information.

Mount Isa Line  
Information Pack

<b>Corridor</b>	<b>KM Point</b>	<b>Speed Board</b>
<i>TRK C087 MNL Hughenden - Cloncurry</i>	375.294	25
	375.330	25
	376.060	25
	376.244	25
	371.019	60
	378.419	25
	378.458	60
	379.271	50
	379.370	60
	379.408	50
	379.510	60
	401.533	25
	401.585	60
	562.134	25
	562.150	60
	562.206	25/60
	562.283	60
	589.346	25
	589.492	60
	637.611	25
	637.716	60
	671.157	60
	672.799	60
	681.320	60
	682.298	60
	682.426	60
	687.108	60
	687.301	60
	687.685	60
	692.047	60
	692.201	60
	693.813	60
	693.968	60
698.576	60	
698.734	60	
698.903	60	
699.025	60	
700.205	60	
700.337	60	
700.581	60	
700.721	60	
702.264	60	
702.957	60	

Queensland Rail does not warrant the fitness for purpose or accuracy of this information.

Mount Isa Line  
Information Pack

<i>Corridor</i>	<i>KM Point</i>	<i>Speed Board</i>
	703.238	60
	705.611	60
	705.756	60
	705.960	60
	706.090	60
	707.559	60
	707.686	60
	708.426	60
	708.773	25
	716.795	60
	720.814	60
	720.989	60
	721.839	60
	721.958	60
	727.938	60
	728.071	60
	728.365	60
	728.498	60
	730.791	60
	731.425	60
	732.312	60
	732.417	60
	736.093	60
	736.223	60
	736.490	60
	736.618	60
	737.582	60
	737.720	60
	738.500	60
	738.642	60
	739.164	60
	739.935	60
	740.529	60
	740.654	60
	742.021	60
	744.342	60
	745.555	60
	746.202	60
	747.219	60
	748.734	60
	749.274	60
	749.973	60
	751.053	60

Queensland Rail does not warrant the fitness for purpose or accuracy of this information.

Mount Isa Line  
Information Pack

<i>Corridor</i>	<i>KM Point</i>	<i>Speed Board</i>
	751.586	60
	752.178	60
	752.403	60
	752.911	60
	753.566	60
	753.979	25/60
	755.067	25
	755.738	60
	757.768	60
	758.414	60
	758.815	60
	759.351	60
	760.027	60
	760.424	60
	760.919	60
	761.396	60
	762.081	60
	763.098	60
	764.779	60
	765.753	60
	766.870	60
	767.009	60
	767.101	25/50
	767.503	50/60
	767.978	25/50
<i>TRK C036 MNL Cloncurry - Flynn Jct</i>	768.506	25
	768.919	25
	769.174	25
	769.691	25
	770.106	25
	770.669	25
	771.749	60
	771.934	60
	773.439	60
	794.192	60
	795.171	60
	795.632	60
	796.158	60
	798.529	60
	799.086	60
	799.859	60
	800.107	60
	800.855	60

Queensland Rail does not warrant the fitness for purpose or accuracy of this information.

Mount Isa Line  
Information Pack

<i>Corridor</i>	<i>KM Point</i>	<i>Speed Board</i>
	801.947	60
	802.858	60
	820.805	25
	821.278	25
	821.939	60
	823.821	60
	825.026	60
	825.563	60
	826.074	60
	828.217	60
	828.349	60
	828.810	60
	828.937	60
	835.319	60
	839.526	60
	841.693	25
	841.837	60
	841.968	60
	842.113	60
	842.260	60
	843.422	60
	843.564	60
	844.409	60
	847.139	60
	847.269	60
	847.684	60
	847.804	60
	848.148	60
	848.540	60
	848.673	60
	848.910	60
	849.038	60
	850.183	60
	850.611	60
	852.089	60
	853.447	60
	854.341	60
	855.297	60
	856.204	60
	856.925	60
	857.319	60
	858.168	60
	858.513	60

Queensland Rail does not warrant the fitness for purpose or accuracy of this information.

Mount Isa Line  
Information Pack

<b>Corridor</b>	<b>KM Point</b>	<b>Speed Board</b>
<i>TRK C075 MNL Flynn - Mt Isa</i>	858.812	60
	859.628	60
	860.031	60
	861.072	60
	861.428	60
	863.097	60
	863.961	60
	864.470	60
	865.179	25
	865.922	25
	868.372	60
	868.631	25
	869.168	60
	870.117	60
	870.953	60
	871.092	60
	871.541	60
	871.682	60
	879.564	25/60
	925.173	60
	925.759	60
	929.022	60
	929.808	60
	930.478	60
	931.765	60
	932.250	60
	932.624	60
	933.739	60
	933.980	60
	934.143	60
	935.026	60
	936.300	60
937.200	60	
938.756	60	
939.245	60	
941.186	25	
941.801	60	
942.697	60	
943.910	60	
944.276	60	
944.896	50	
945.041	50	
945.491	60	



Queensland Rail does not warrant the fitness for purpose or accuracy of this information.

Mount Isa Line  
Information Pack

<b>Corridor</b>	<b>KM Point</b>	<b>Speed Board</b>
	947.155	60
	949.333	60
	949.899	60
	950.473	60
	952.210	60
	952.973	60
	953.181	60
	953.962	60
	954.520	60
	955.296	60
	956.025	60
	956.649	60
	956.856	60
	958.834	60
	959.850	60
	960.404	60
	961.194	60
	963.001	60
	963.863	60
	964.862	25
	967.796	15
	969.532	25
	969.646	25
	969.912	25
	970.320	25
	970.368	25
	970.427	25
	970.620	25
	970.662	25
	970.738	25
	970.790	25
	970.892	25
	971.450	25
	971.610	25
TRK C036 Pass Loop 1 @Bungalien	866.200	25
TRK C036 Pass Loop 1 @Cloncurry	769.316	25
	769.703	25
	770.117	25
	770.432	25
TRK C036 Pass Loop 1 @Malbon	820.741	25
	821.267	25
	821.792	25
TRK C036 Pass Loop 1 @Marimo	785.564	25

Queensland Rail does not warrant the fitness for purpose or accuracy of this information.

Mount Isa Line  
Information Pack

<b>Corridor</b>	<b>KM Point</b>	<b>Speed Board</b>
	785.747	25
	786.622	25
TRK C036 Pass Loop 1 @Wammutta	840.648	25
	841.694	25
TRK C075 Mainline Down @Woonigan	906.234	25
	906.493	25
	907.319	25
TRK C075 Pass Loop 1 @Duchess	878.436	25
	879.486	25
TRK C075 Pass Loop 1 @Rifle Ck	940.622	25
	941.186	25
	941.669	25
TRK C087 Mainline Down @Pymurra	742.518	25
	743.569	25
TRK C087 Pass Loop 1 @Gemoka	518.445	25
	519.494	25
TRK C087 Pass Loop 1 @Gilliat	663.239	25
	664.265	25
TRK C087 Pass Loop 1 @Julia Ck	637.472	25
	637.625	25
	638.526	25
TRK C087 Pass Loop 1 @Marathon	442.837	25
	443.881	25
TRK C087 Pass Loop 1 @Maxwelton	539.869	25
	540.939	25
TRK C087 Pass Loop 1 @Moselle	468.630	25
	469.681	25
TRK C087 Pass Loop 1 @Mumu	419.962	25
	421.011	25
TRK C087 Pass Loop 1 @Nelja	589.274	25
	589.457	25
	590.326	25
TRK C087 Pass Loop 1 @Nonda	561.253	25
	562.106	25
TRK C087 Pass Loop 1 @Oonomurra	754.377	25
	755.067	25
TRK C087 Pass Loop 1 @Oorindi	709.835	25
TRK C087 Pass Loop 1 @Quarrells	613.465	25
	614.508	25
TRK C087 Pass Loop 1 @Richmond	490.402	25
	491.615	25
TRK C087 Pass Loop 1 @Tibarri	683.876	25
	684.900	25

Queensland Rail does not warrant the fitness for purpose or accuracy of this information.

Mount Isa Line  
Information Pack

<b>Corridor</b>	<b>KM Point</b>	<b>Speed Board</b>
TRK C087 Pass Loop 1 @Undina	724.952	25
	725.997	25
TRK C188 No.3 Rd @Hughenden	376.060	25
TRK C188 Pass Loop 1 @Antil Plains	9.777	25
	10.919	25
	170.230	25
TRK C188 Pass Loop 1 @Balfes Ck	170.278	25
	170.500	25
	269.458	25
TRK C188 Pass Loop 1 @Burra	270.606	25
	127.846	25
TRK C188 Pass Loop 1 @Charters Towers	129.295	25
	81.318	25
TRK C188 Pass Loop 1 @Mingela	81.689	25
	185.344	25
TRK C188 Pass Loop 1 @Mungunburra	185.409	25
	186.489	25
	234.584	25
TRK C188 Pass Loop 1 @Pentland	234.897	25
	235.499	25
	235.702	25
	332.791	25
TRK C188 Pass Loop 1 @Prairie	333.958	25
	46.873	25
TRK C188 Pass Loop 1 @Reid River	47.447	25
	48.052	25
	109.916	25
TRK C188 Pass Loop 1 @Sellheim	111.032	25
	111.203	25
	351.890	25
TRK C188 Pass Loop 1 @Tindo	352.275	25
	353.064	25
	289.054	25
TRK C188 Pass Loop 1 @Torrens Ck	289.382	25
	254.925	25
TRK C188 Pass Loop 1 @Warrigal	255.032	25
	255.830	25
	256.066	25
	58.126	25
TRK C188 Pass Loop 1 @Woldston	59.284	25
	27.610	25
TRK C188 Pass Loop 1 @Woodstock	28.762	25

Queensland Rail does not warrant the fitness for purpose or accuracy of this information.

Mount Isa Line  
Information Pack

## PHOSPHATE HILL LINE

INCREASING DISTANCE IS THE "UP" DIRECTION

### LOCATION OF SPEED BOARDS

LINE CODE	TRACK	DISTANCE km	FEATURE	SPEEDBOARDS	
				DOWN TRAIN TO FLYNN	UP TRAIN - TO PHOSPHATEHILL
<b>FLYNN TO PHOSPHATE HILL</b>					
637	MAIN	868.776	SPEED BOARDS	80	L50/80
644	EAST ANGLE	0.100	CURVE SPRING	50	60
644	SINGLE	1.151	SPEED BOARDS	L50/60	80
644	SINGLE	24.276	SPEED BOARDS	80p	25
644	UP MAIN	24.890	<b>PILGRIM</b>		
644	SINGLE	25.507	SPEED BOARDS	25	80
644	SINGLE	49.624	SPEED BOARD	80p	25
644	UP MAIN	50.240	<b>MIRRI</b>		
644	SINGLE	50.862	SPEED BOARD	25	80
644	SINGLE	62.474	SPEED BOARDS	80	25
644	BALLOON	62.689	CURVE END	25	40
644	BALLOON	65.595	SPEED BOARDS	25	40
644	BALLOON	66.060	<b>PHOSPHATE HILL</b>		

Queensland Rail does not warrant the fitness for purpose or accuracy of this information.

Mount Isa Line  
Information Pack

# APPENDIX E Track Data & Grade Diagrams

## Great Northern Railway (GNR) - MTrain Download 16-12-05

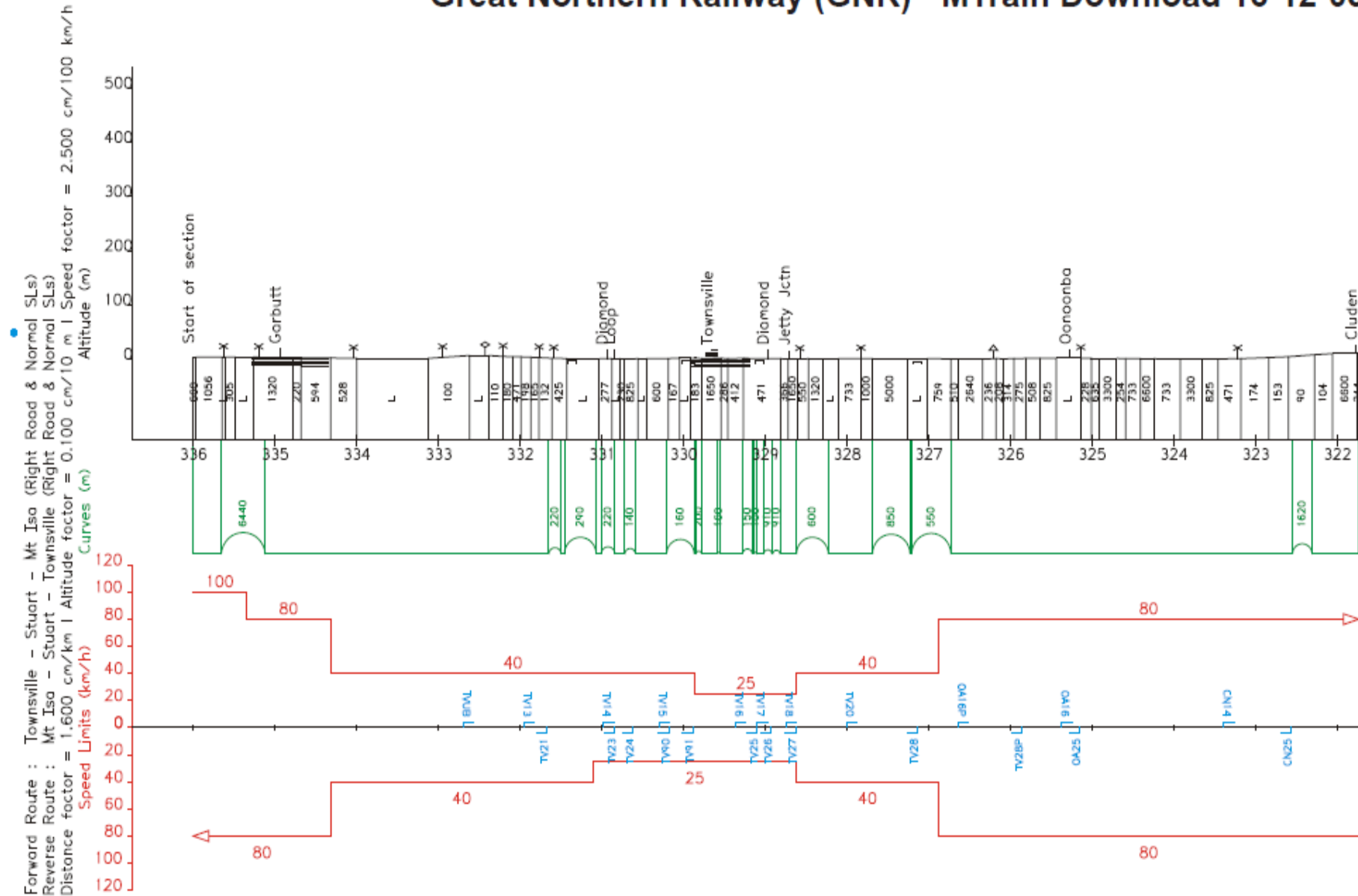

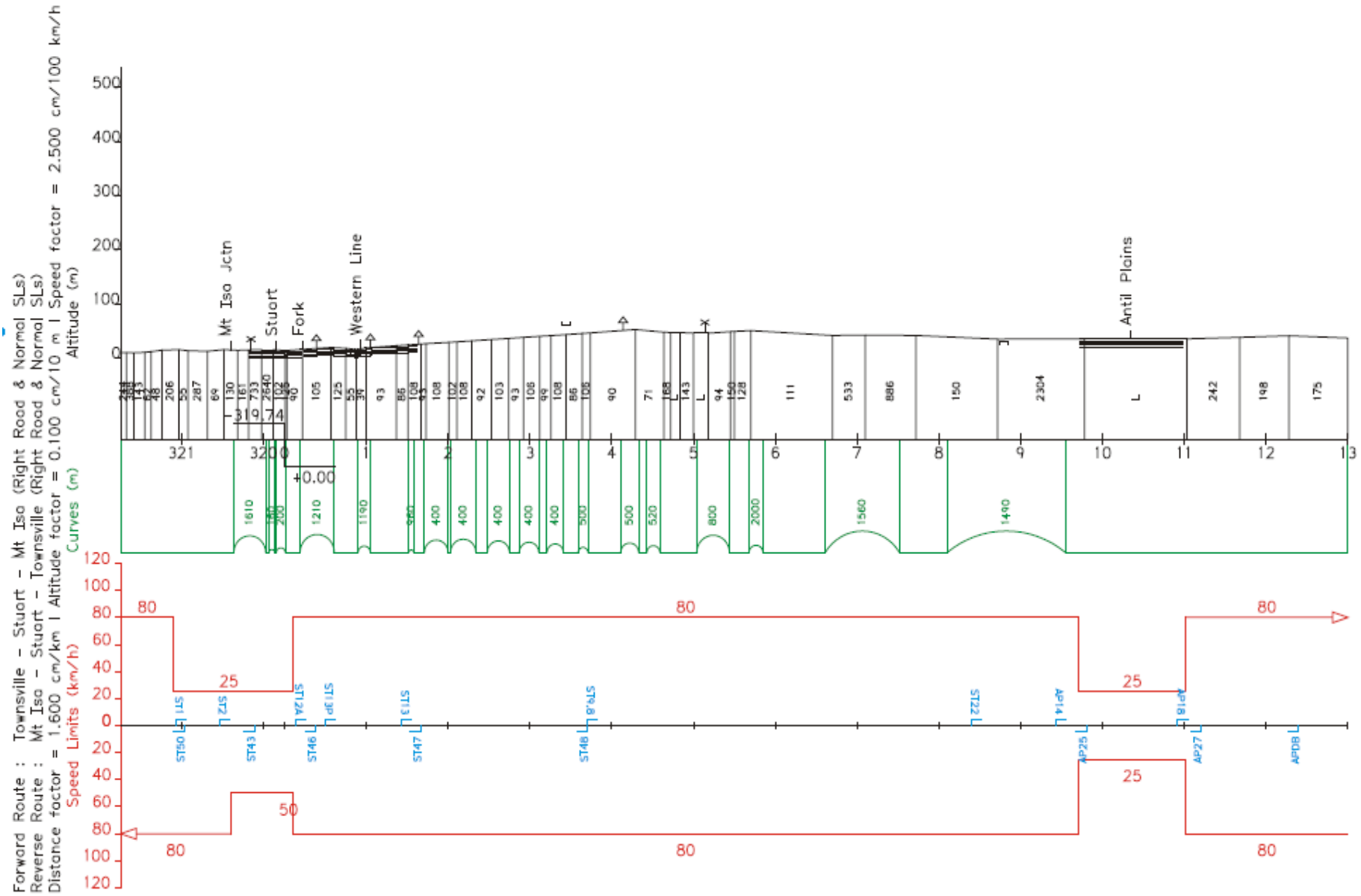

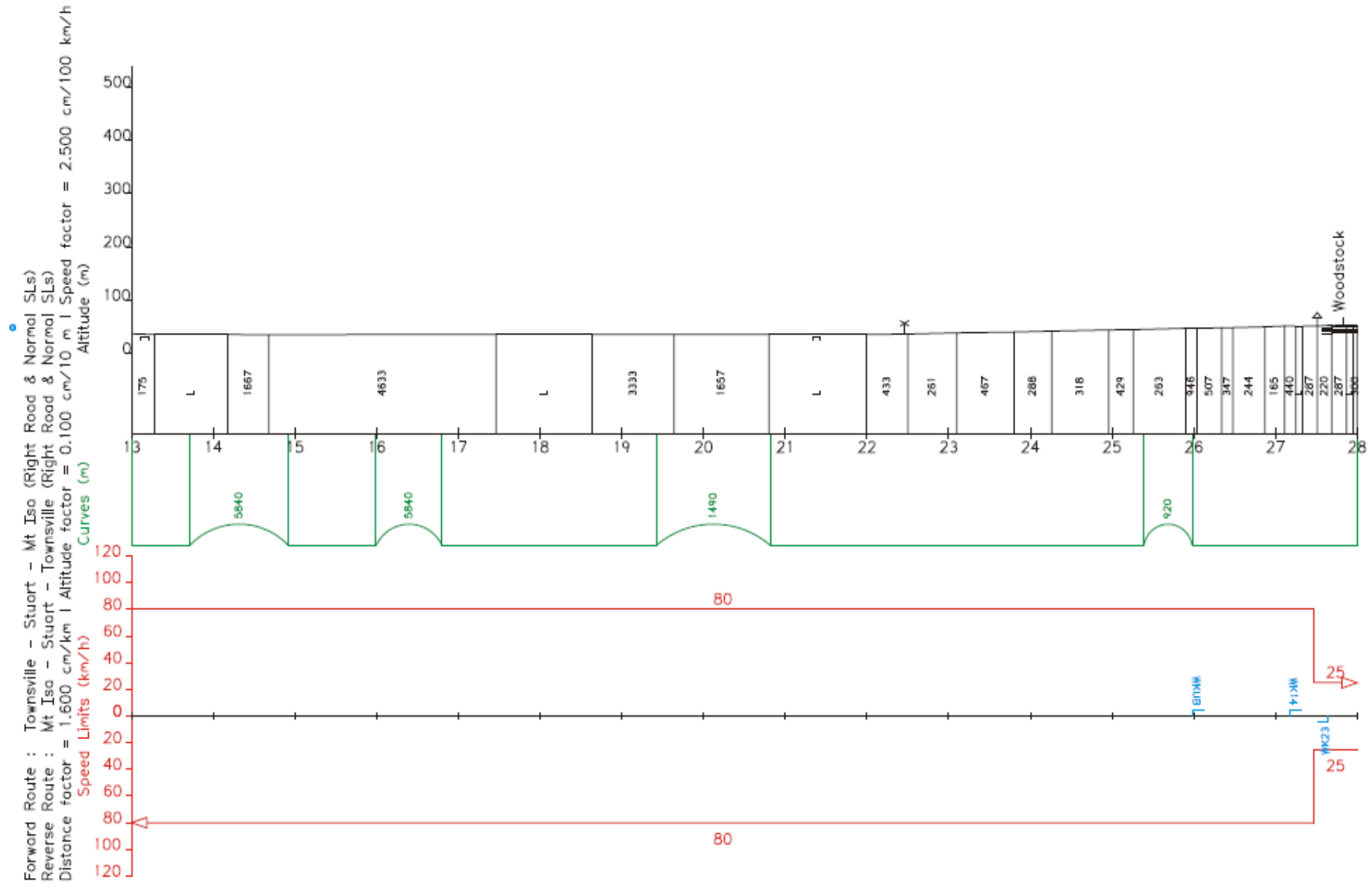



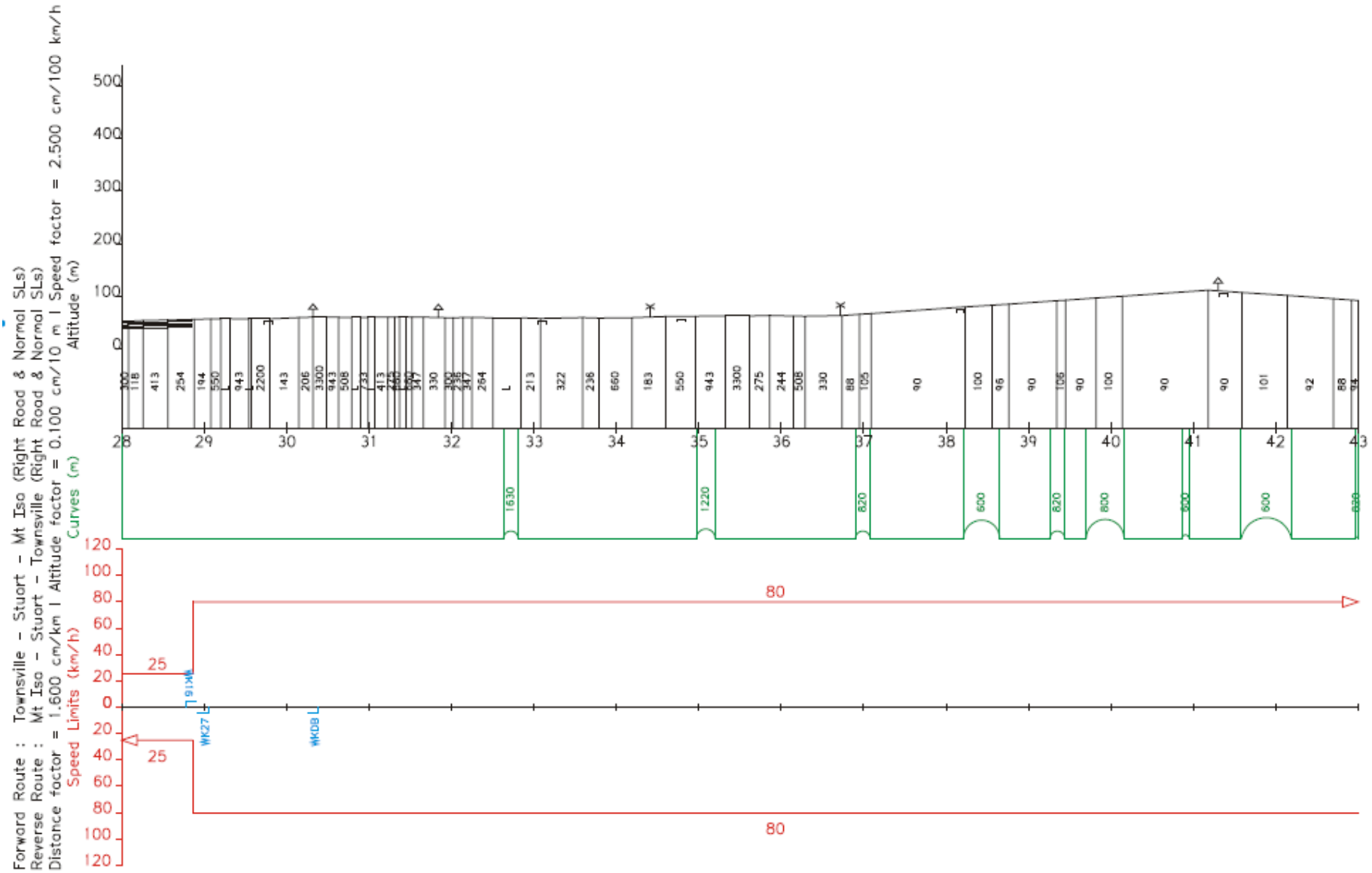

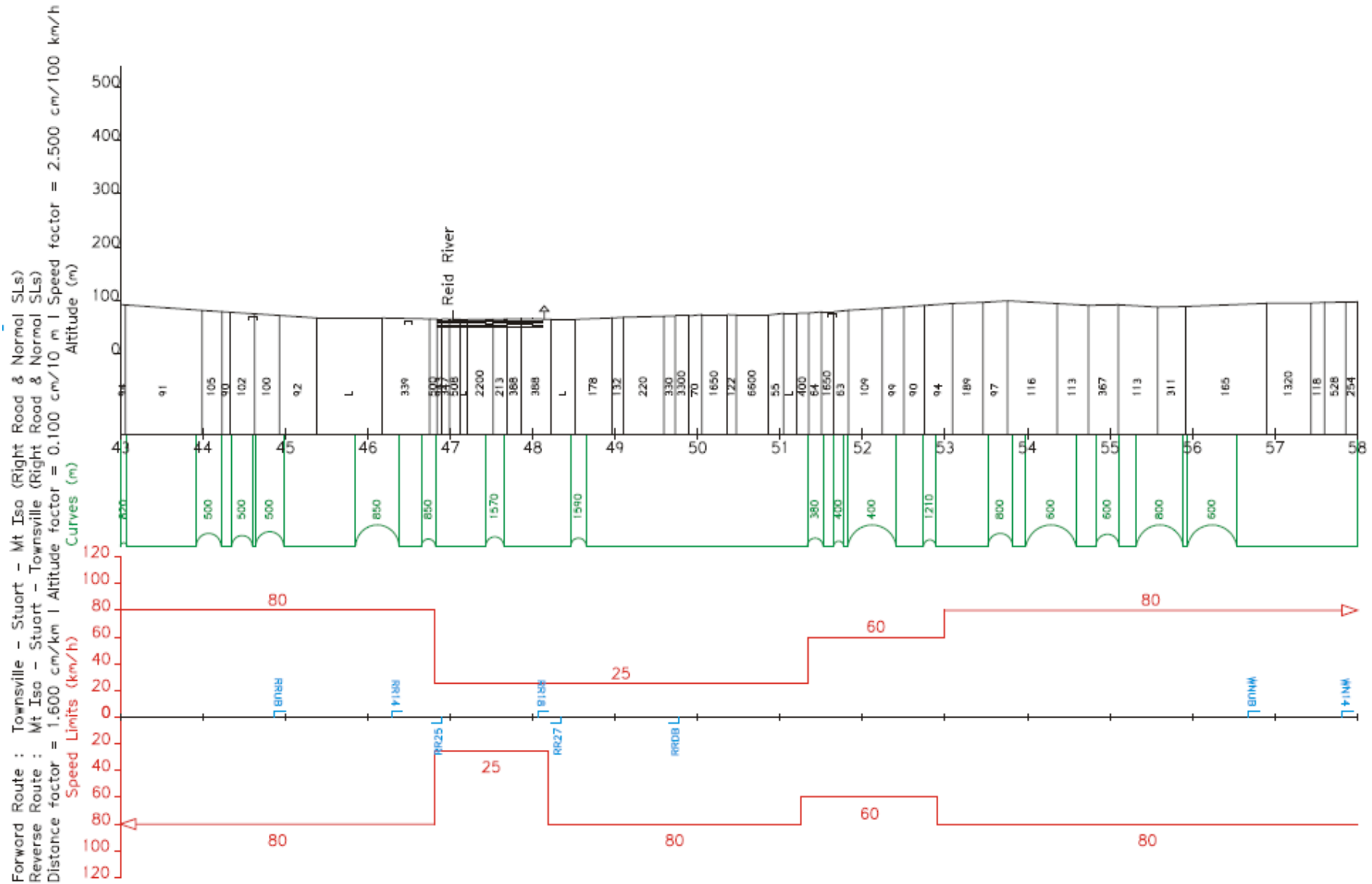

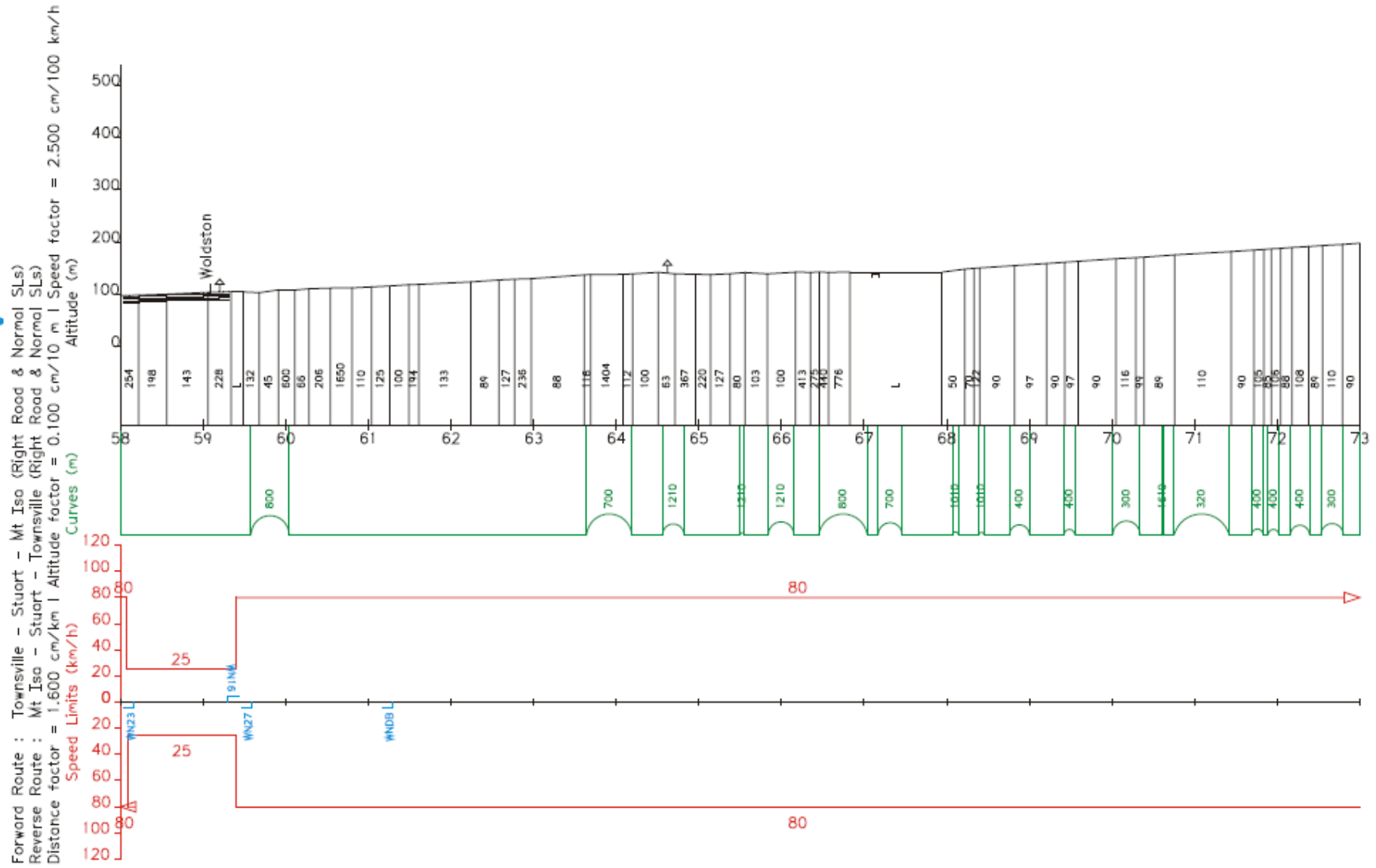

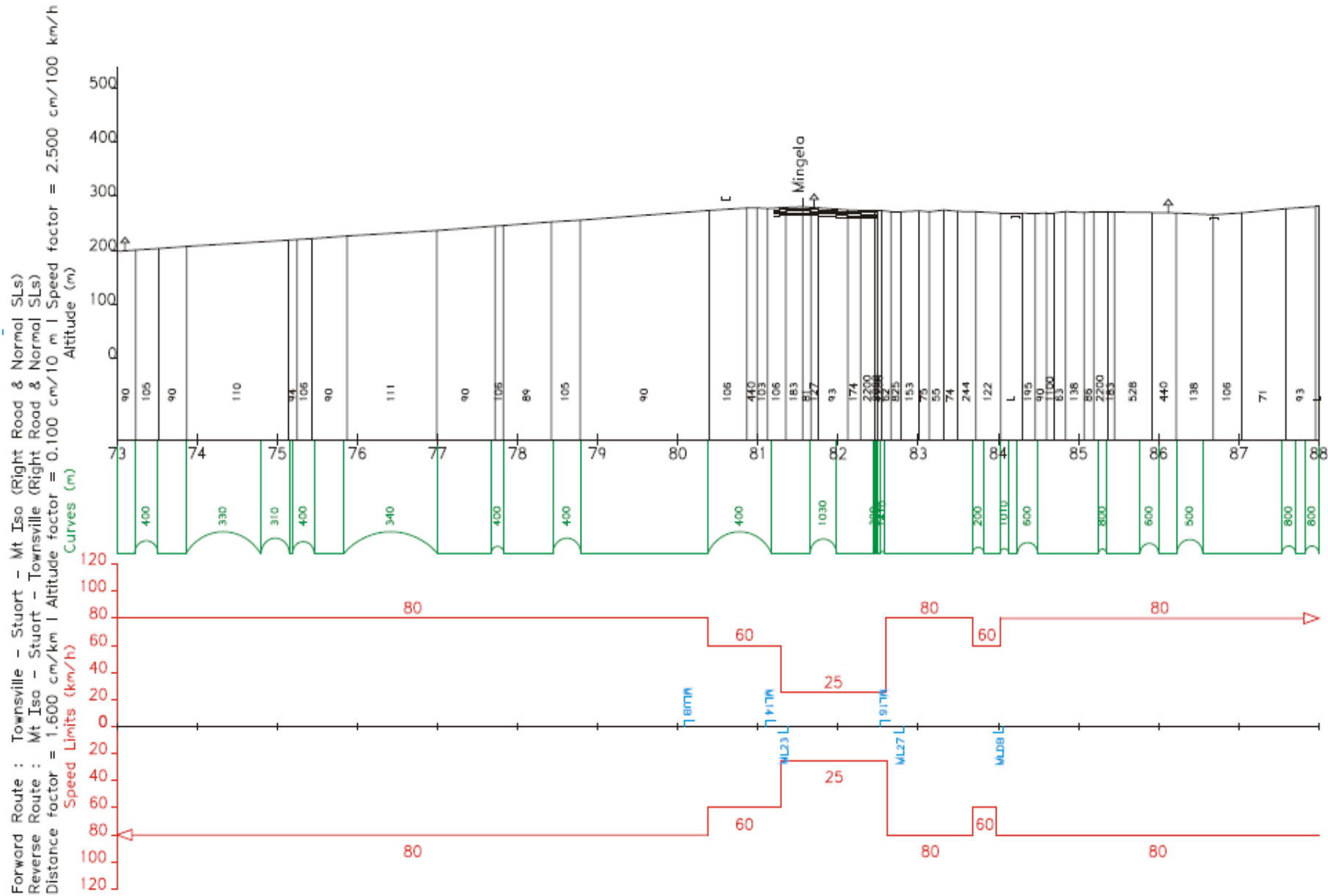

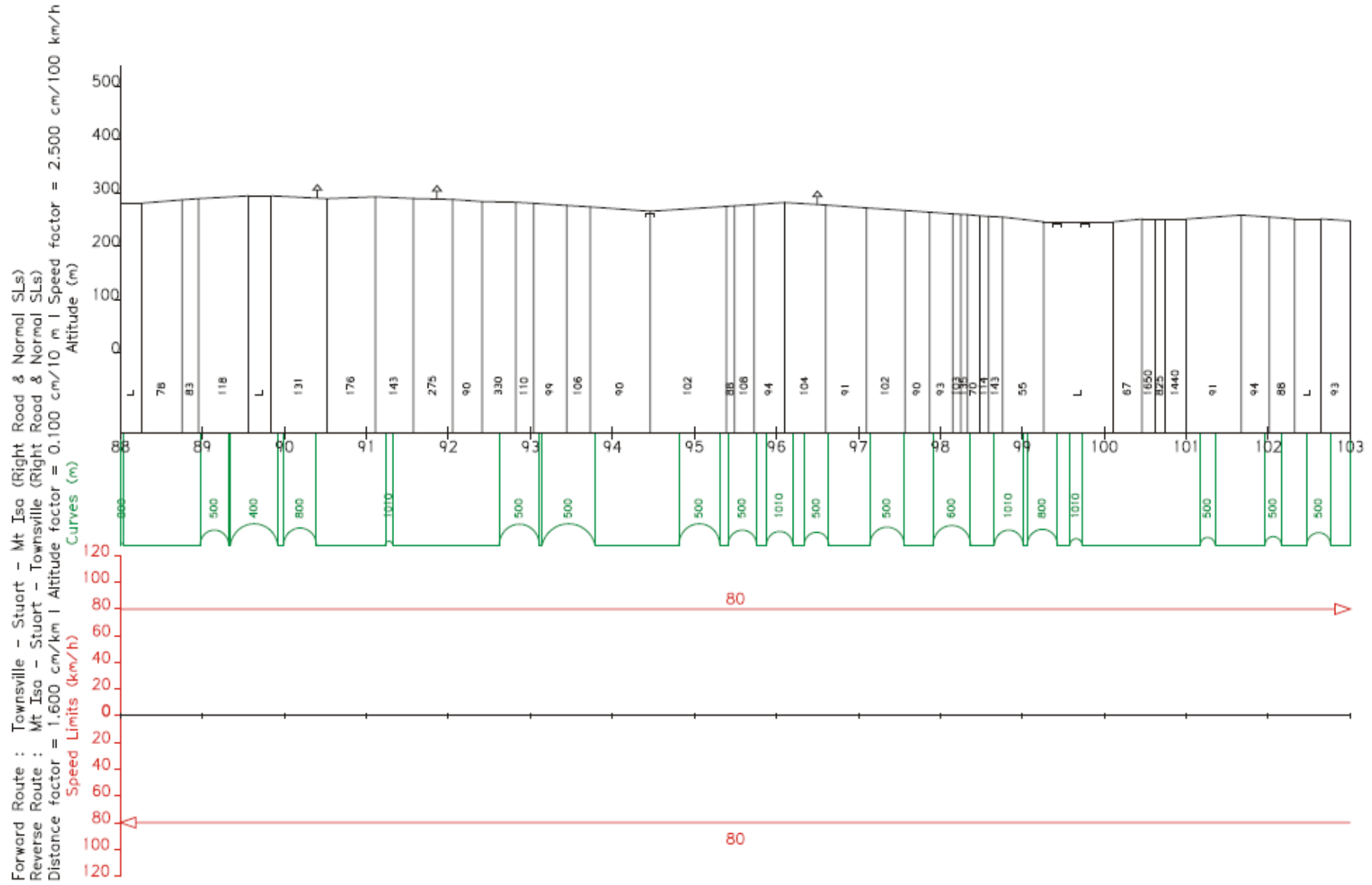

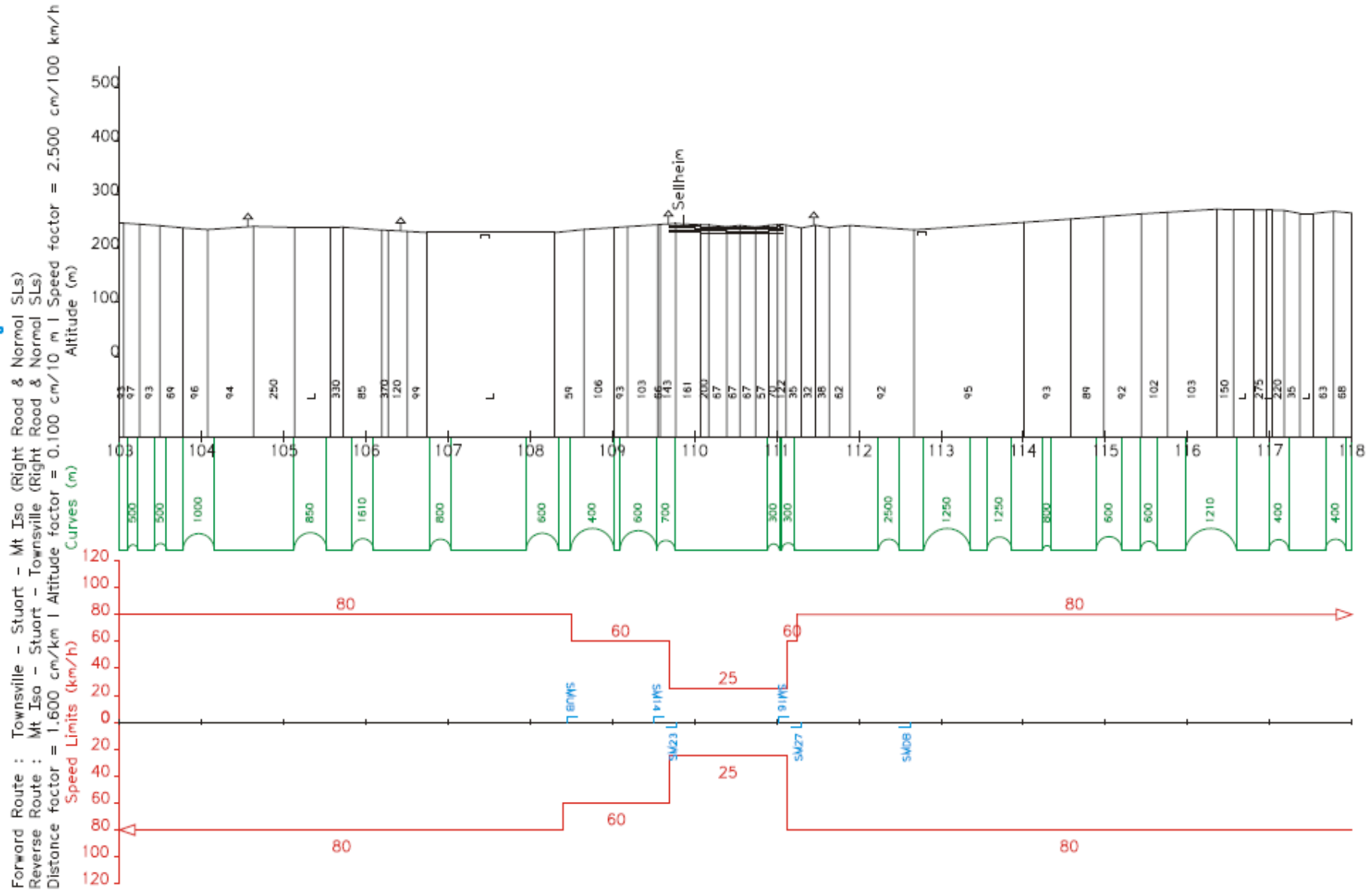

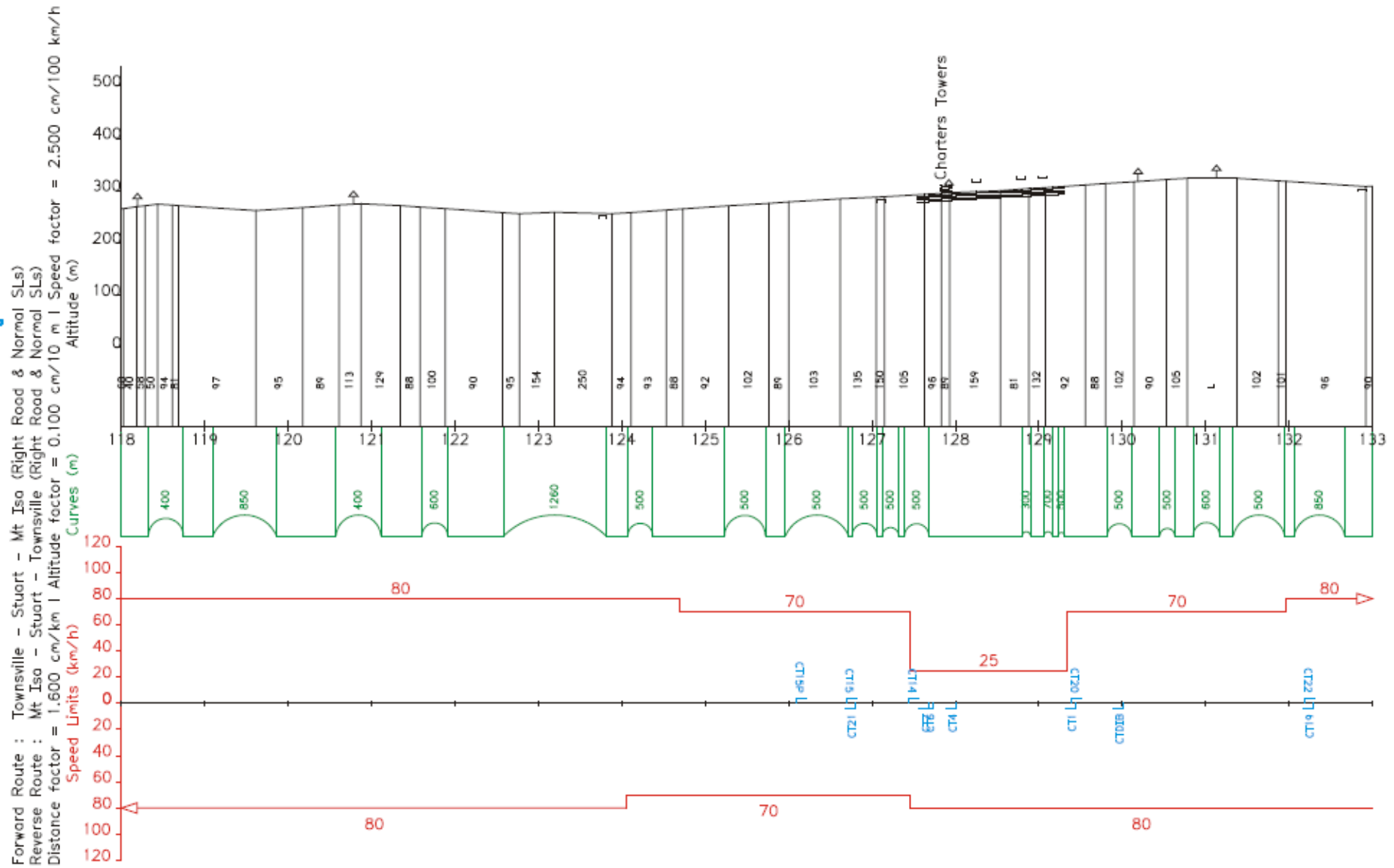

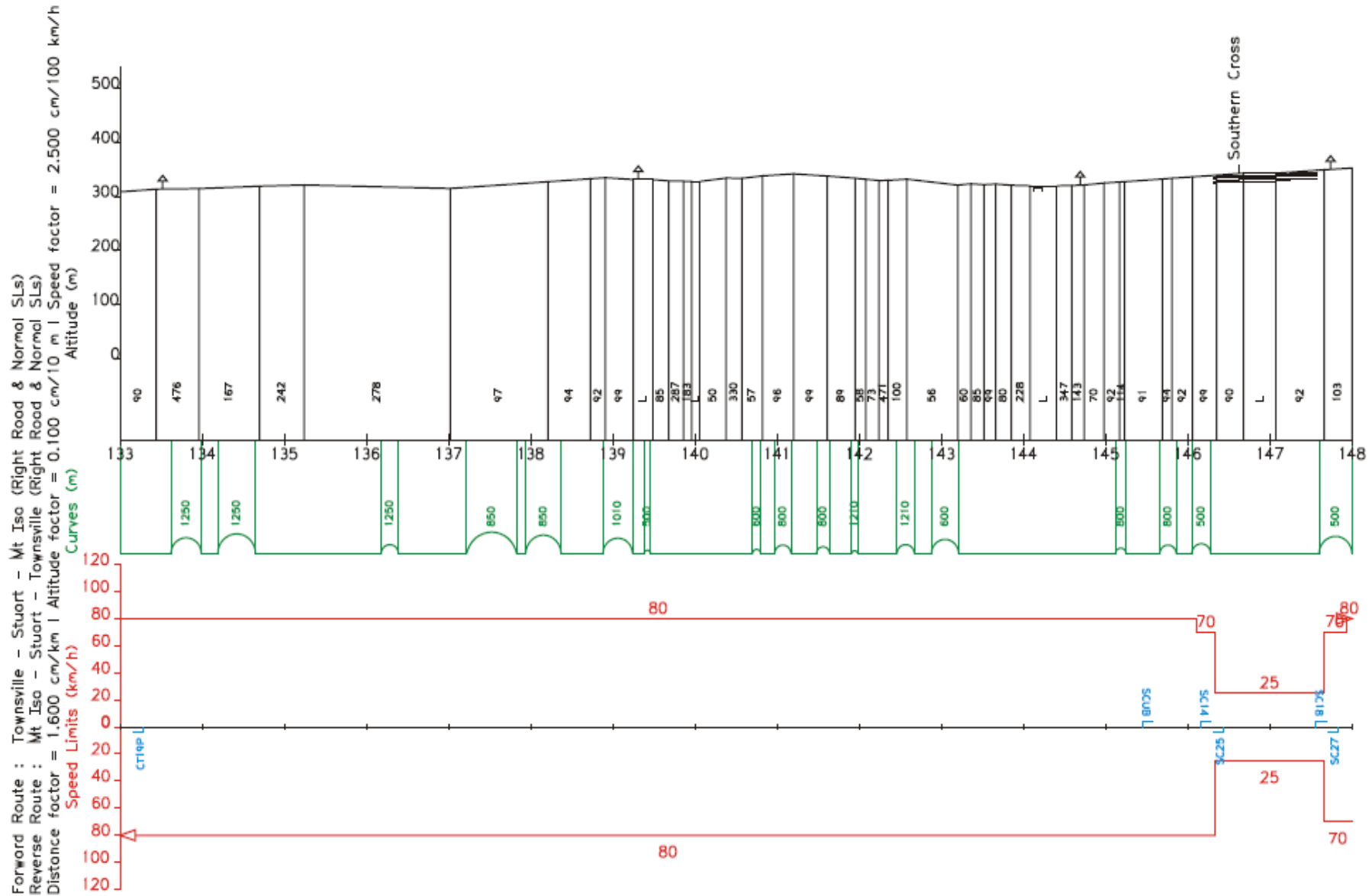



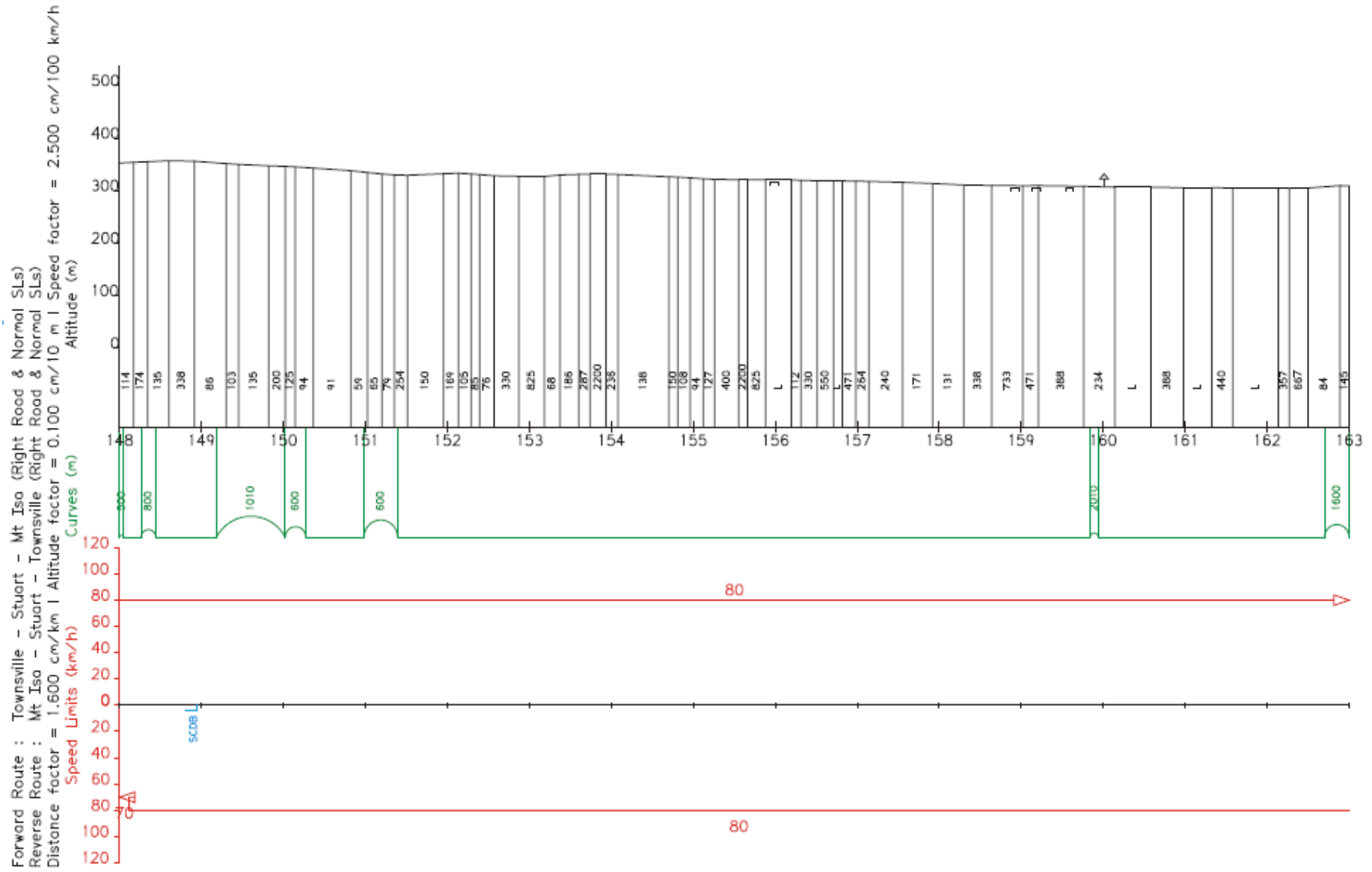

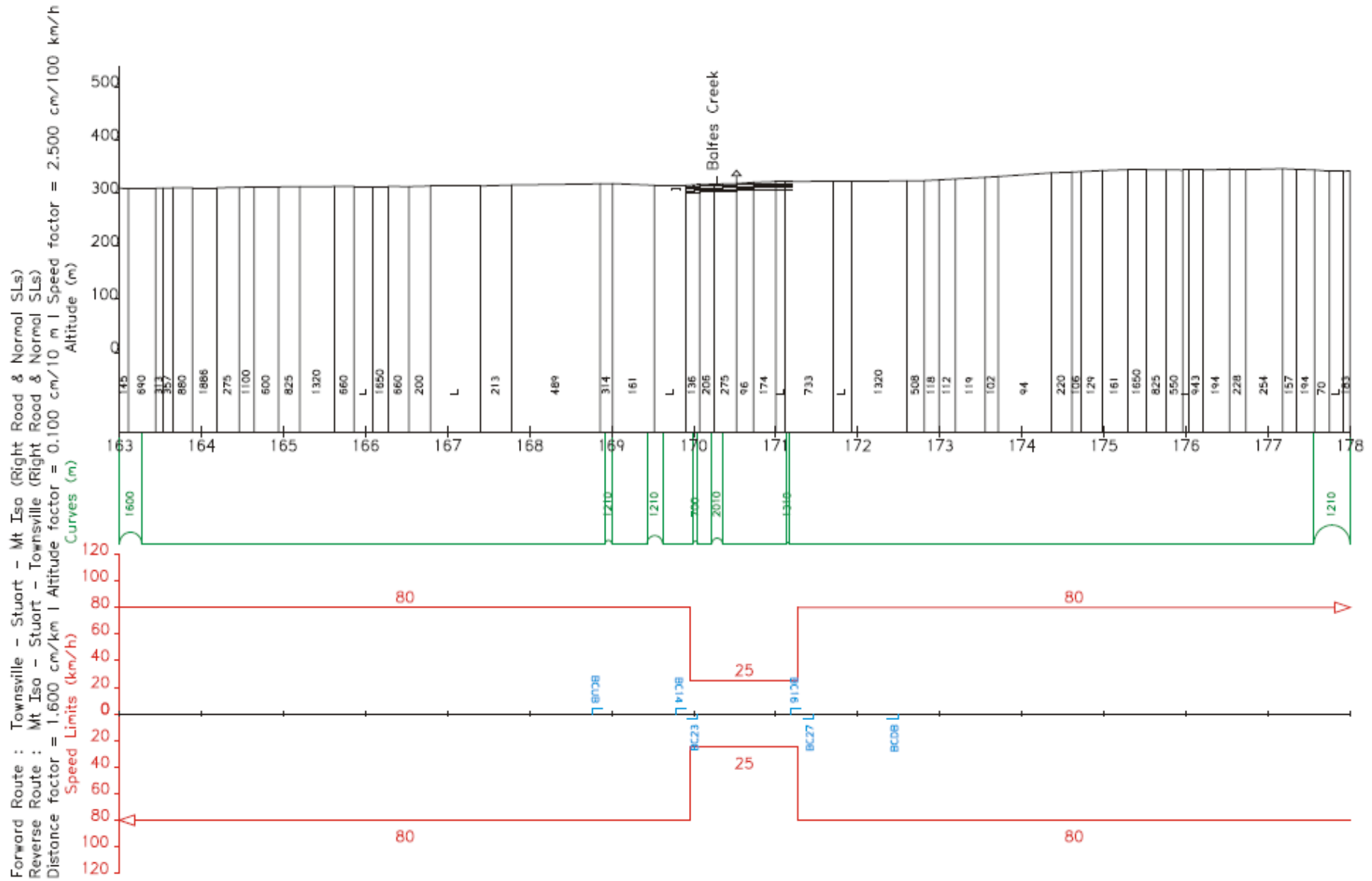

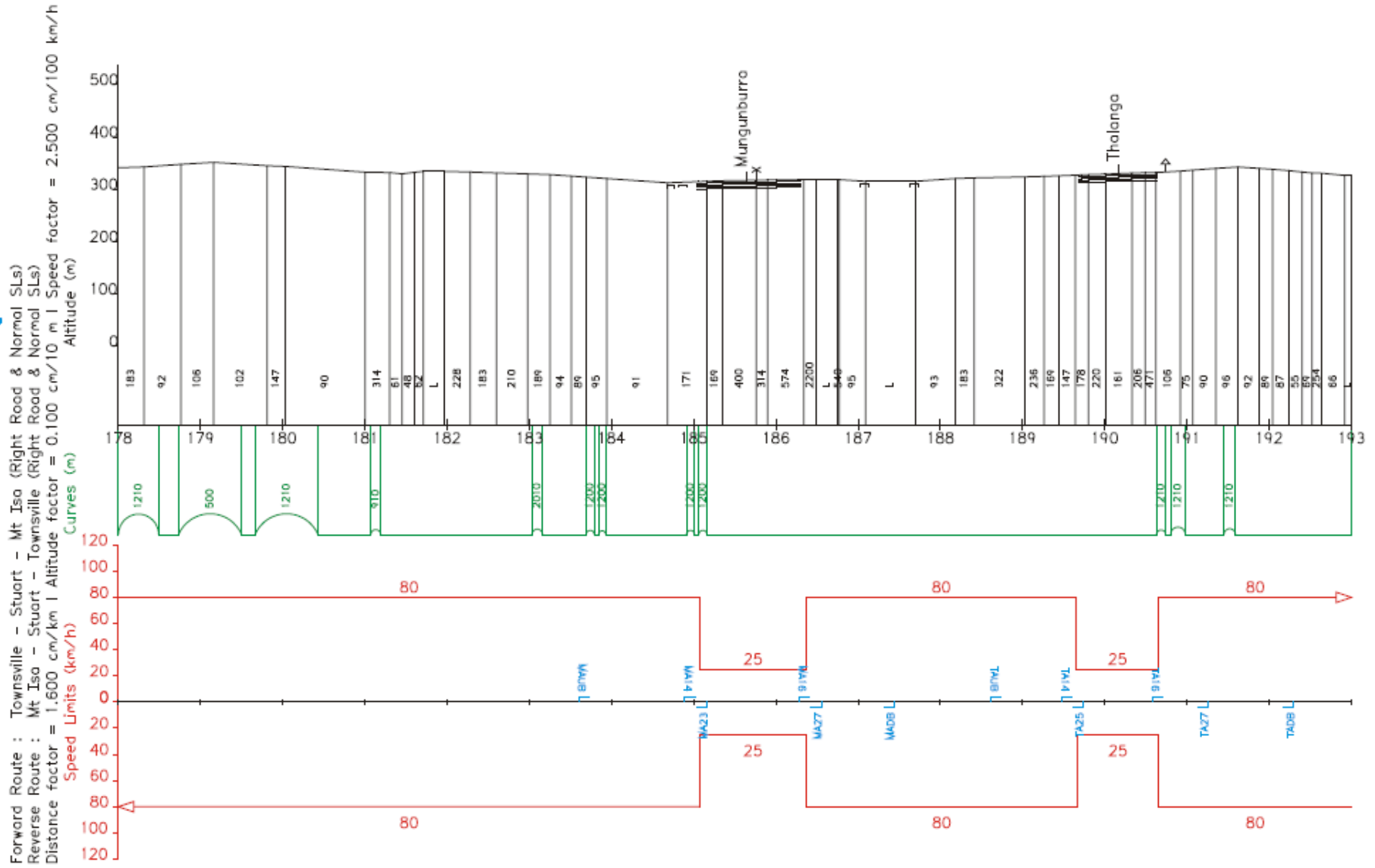

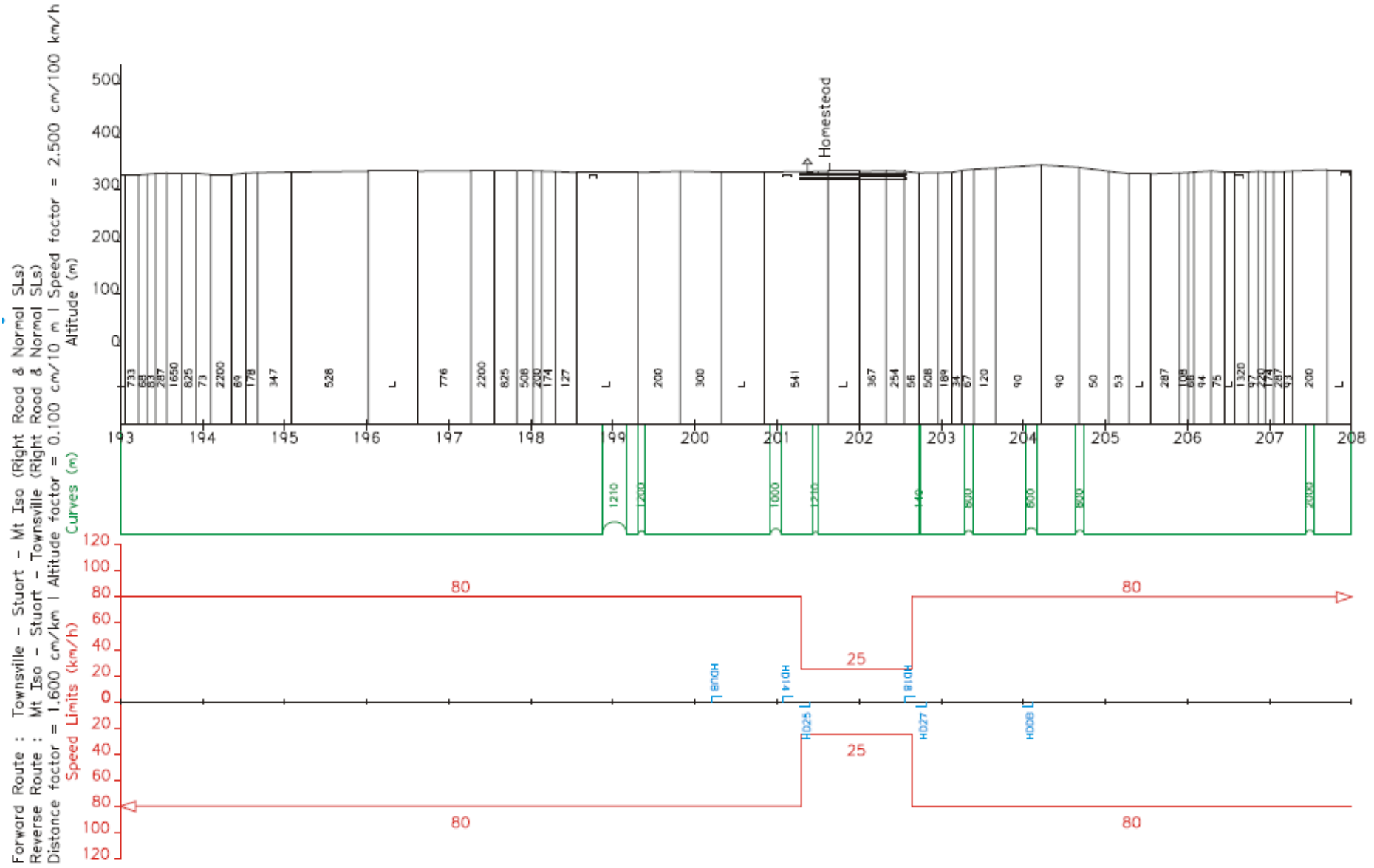

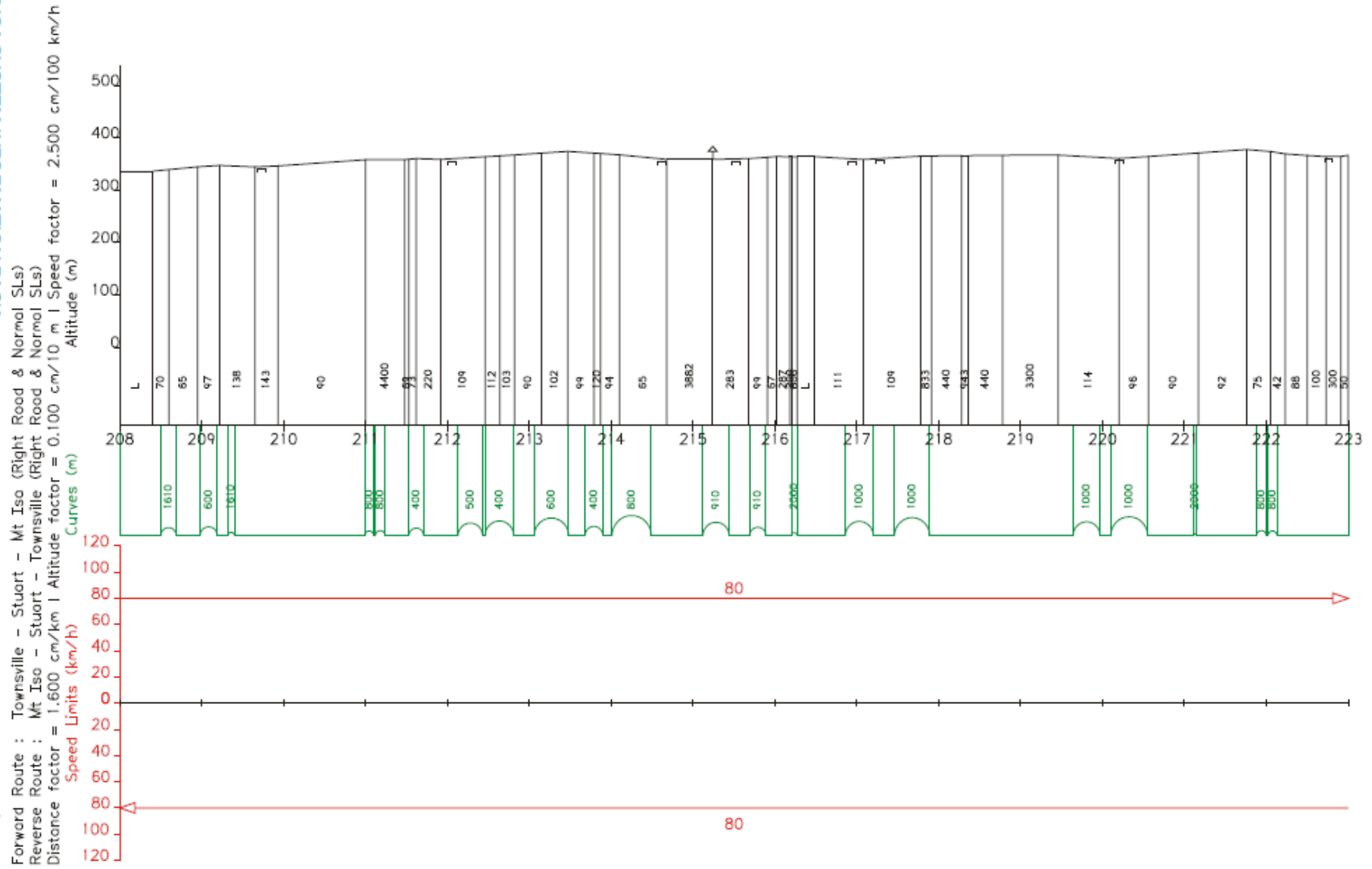

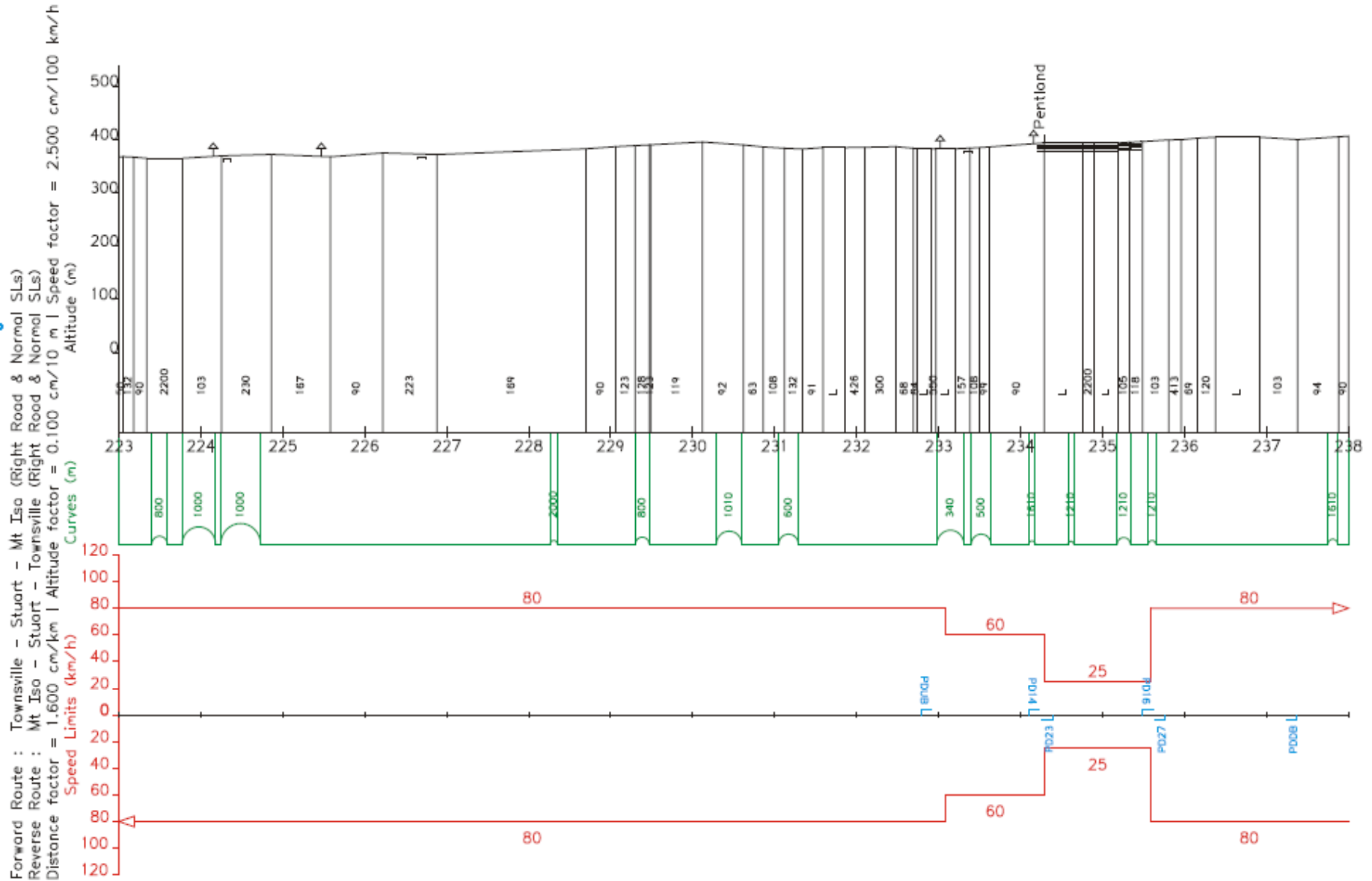

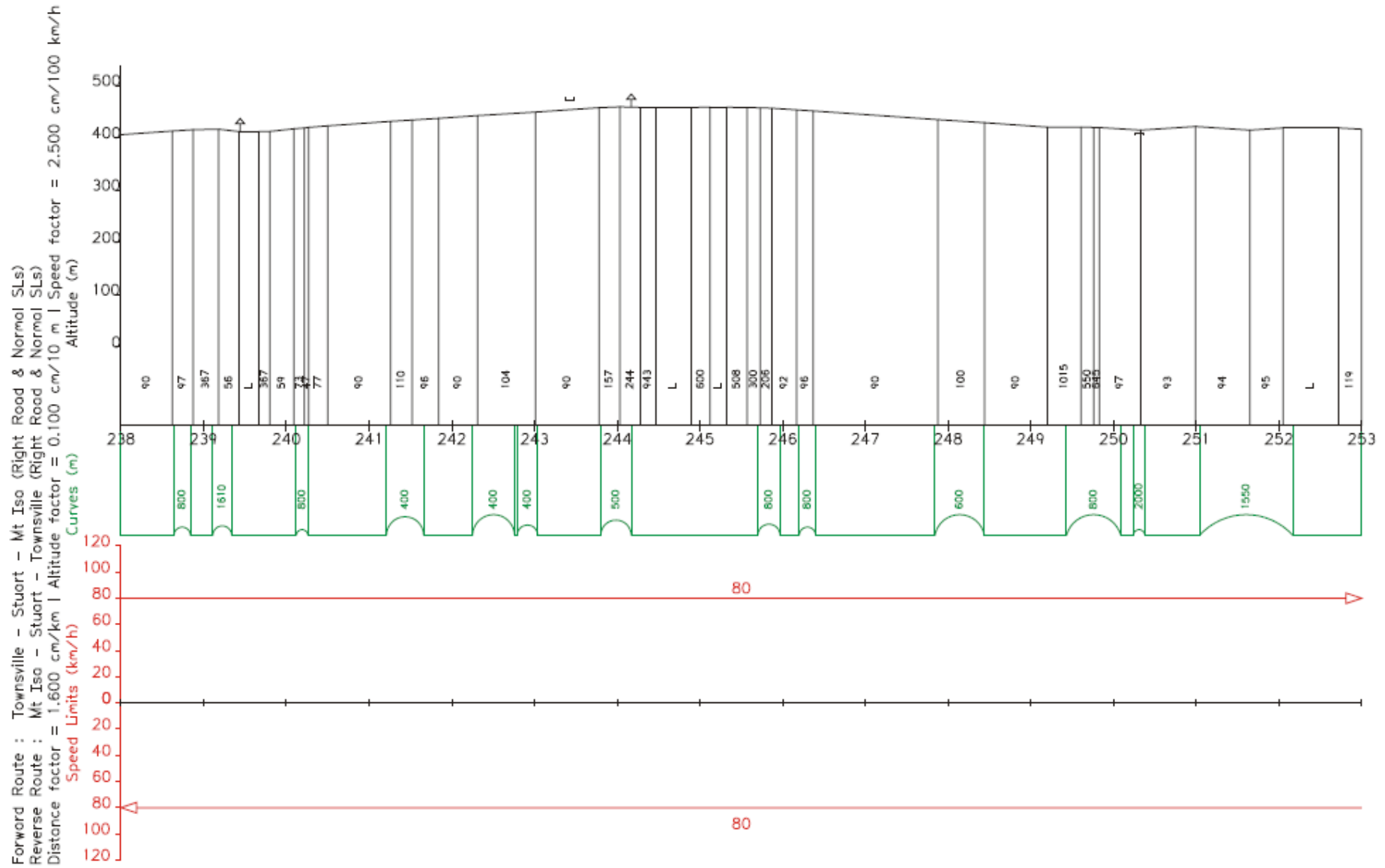

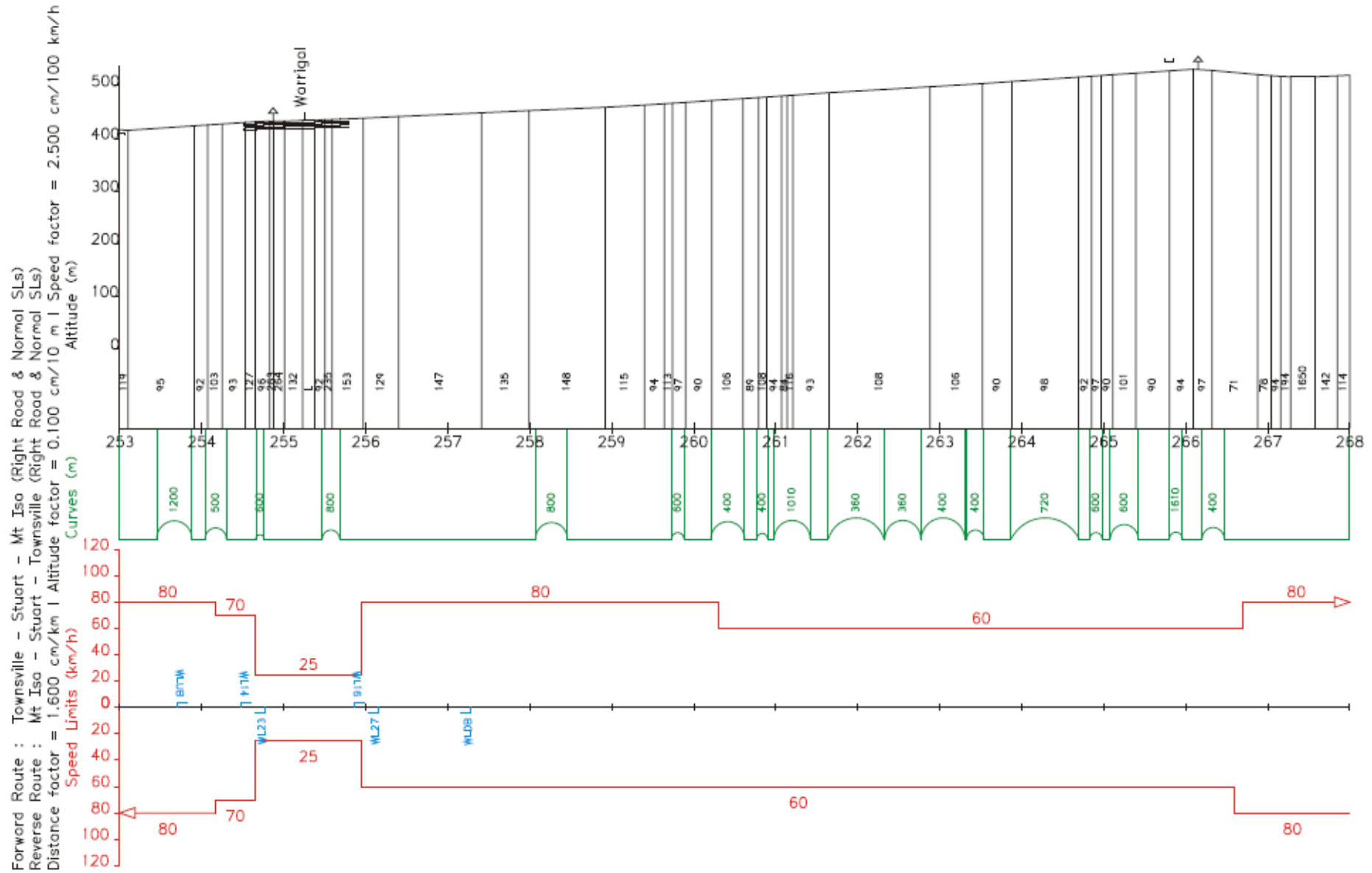



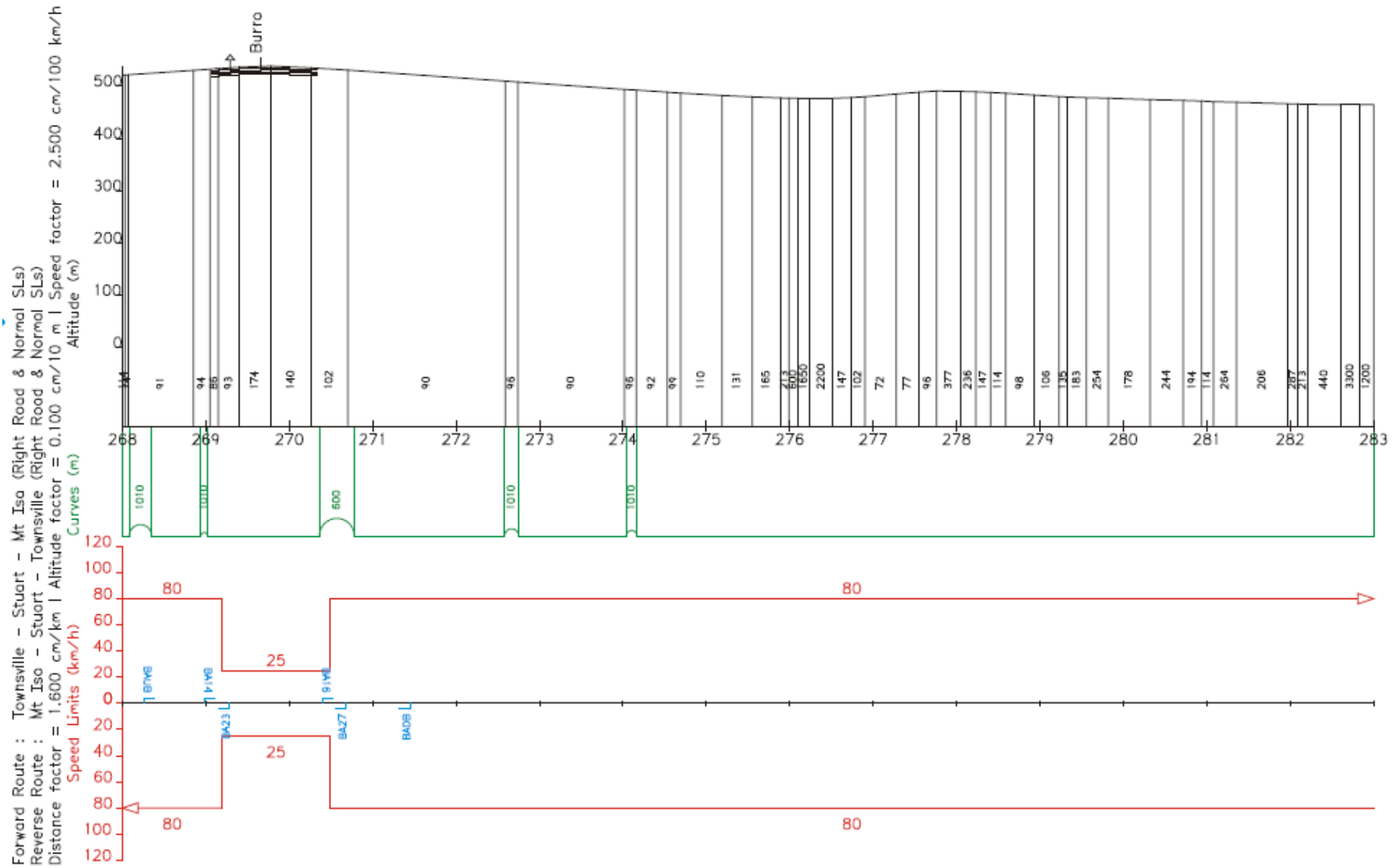

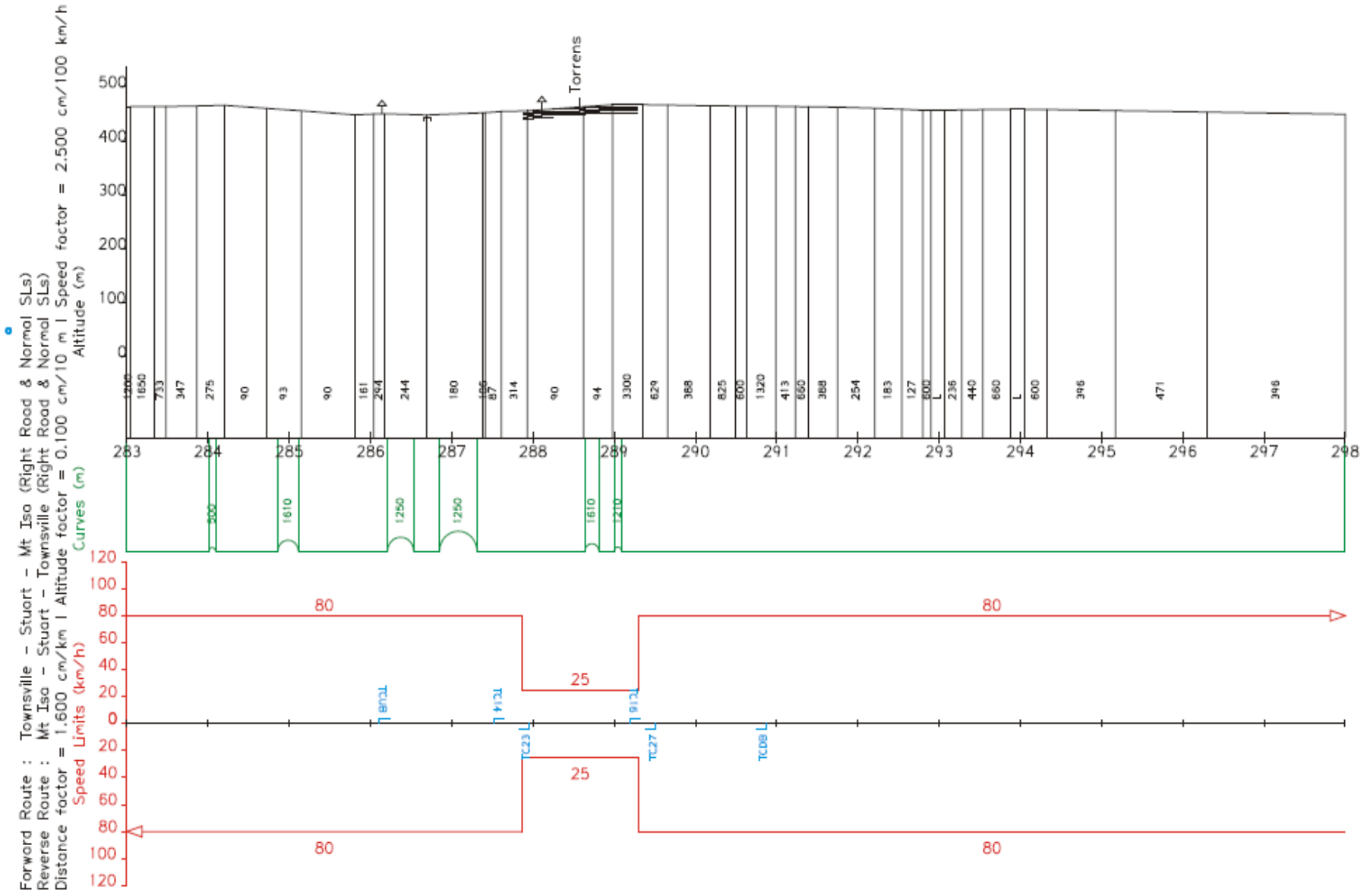

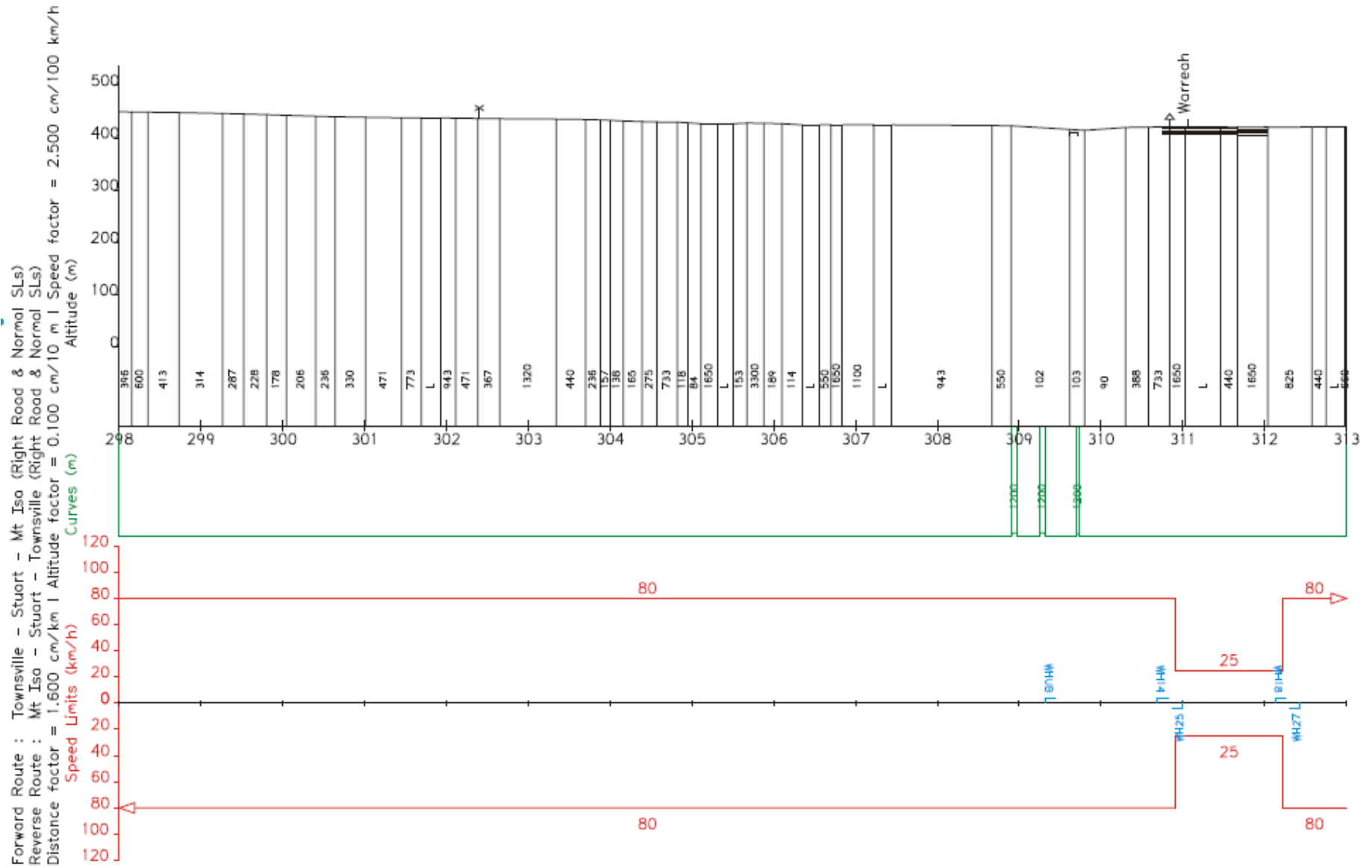

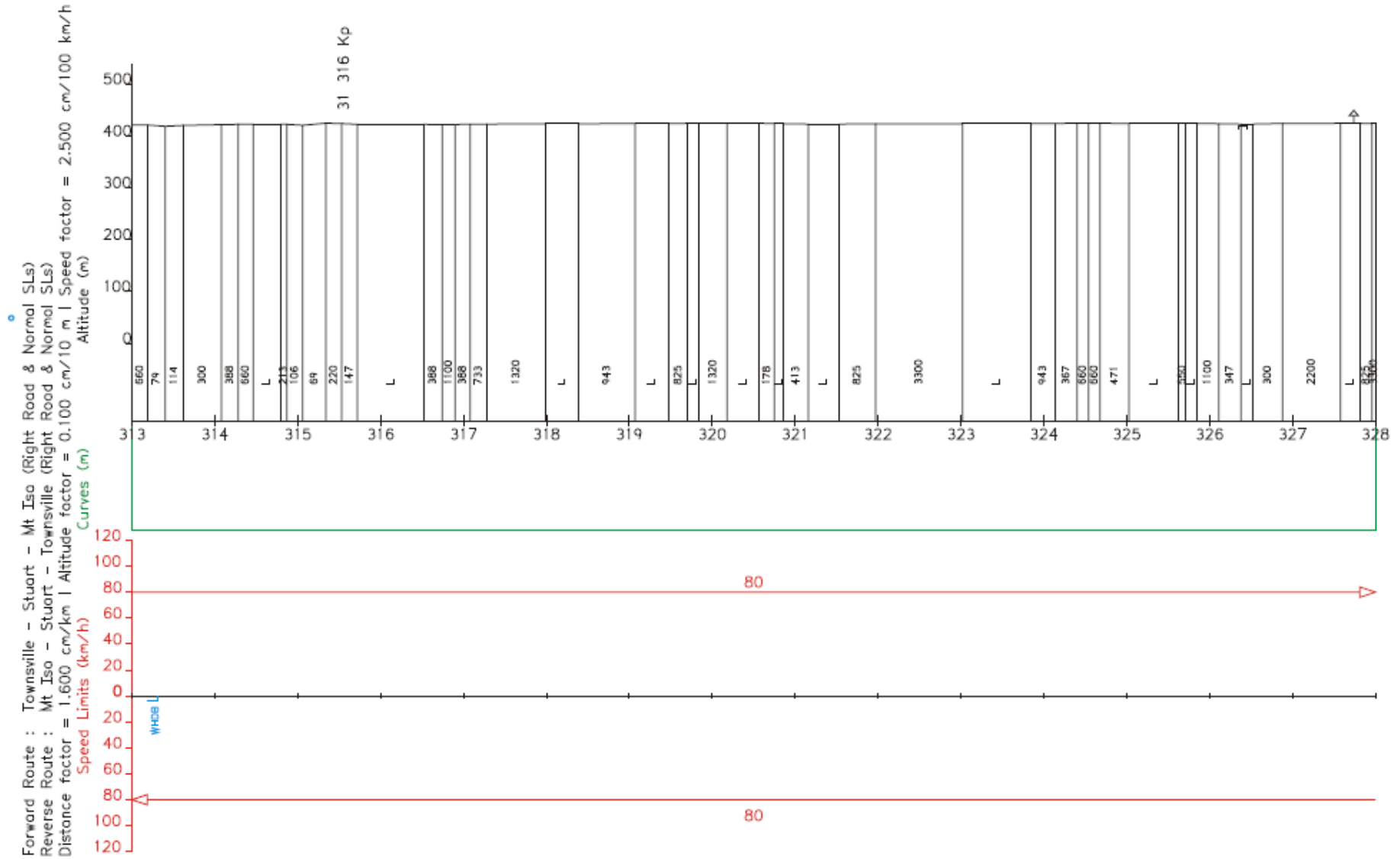

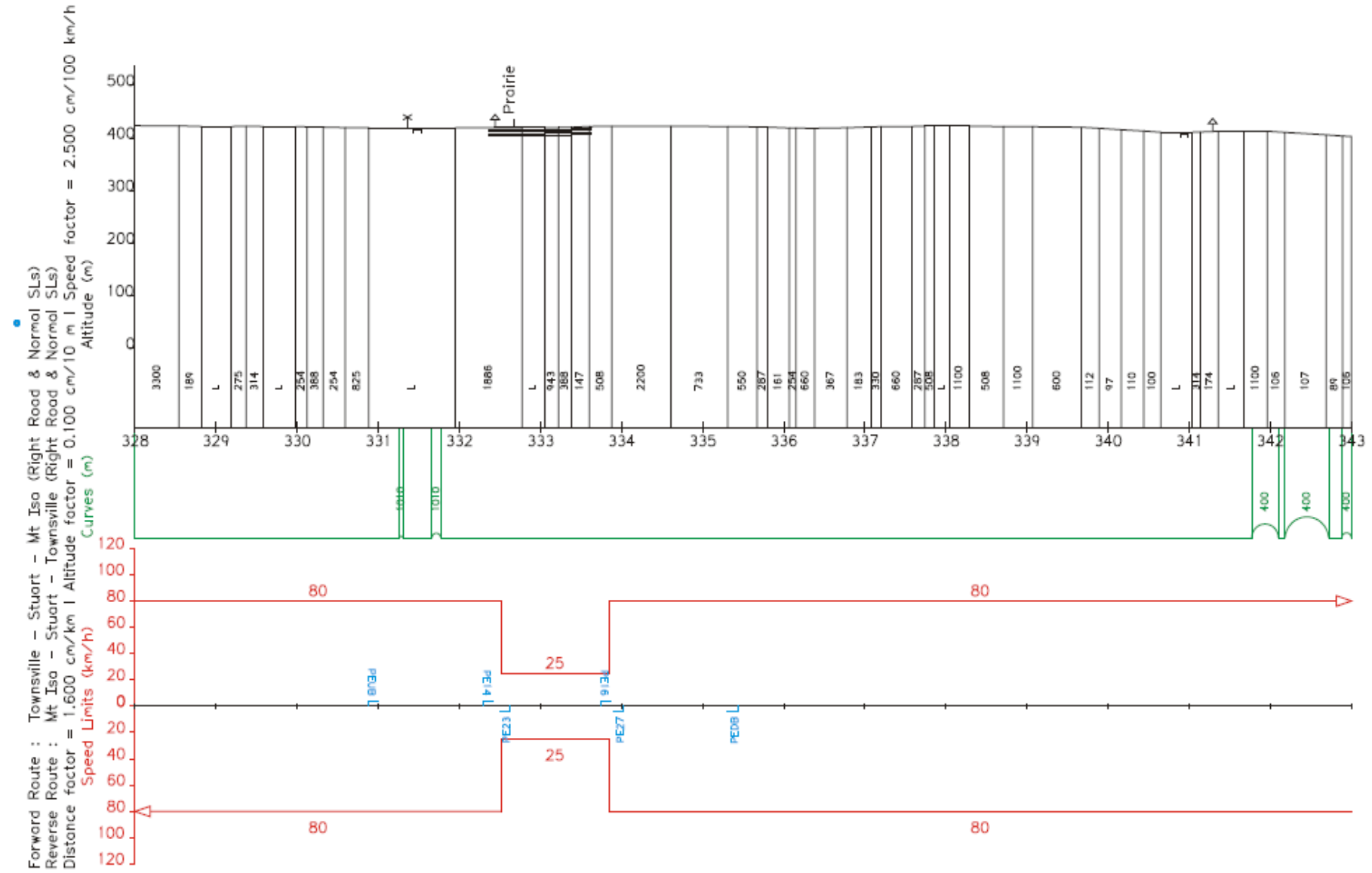

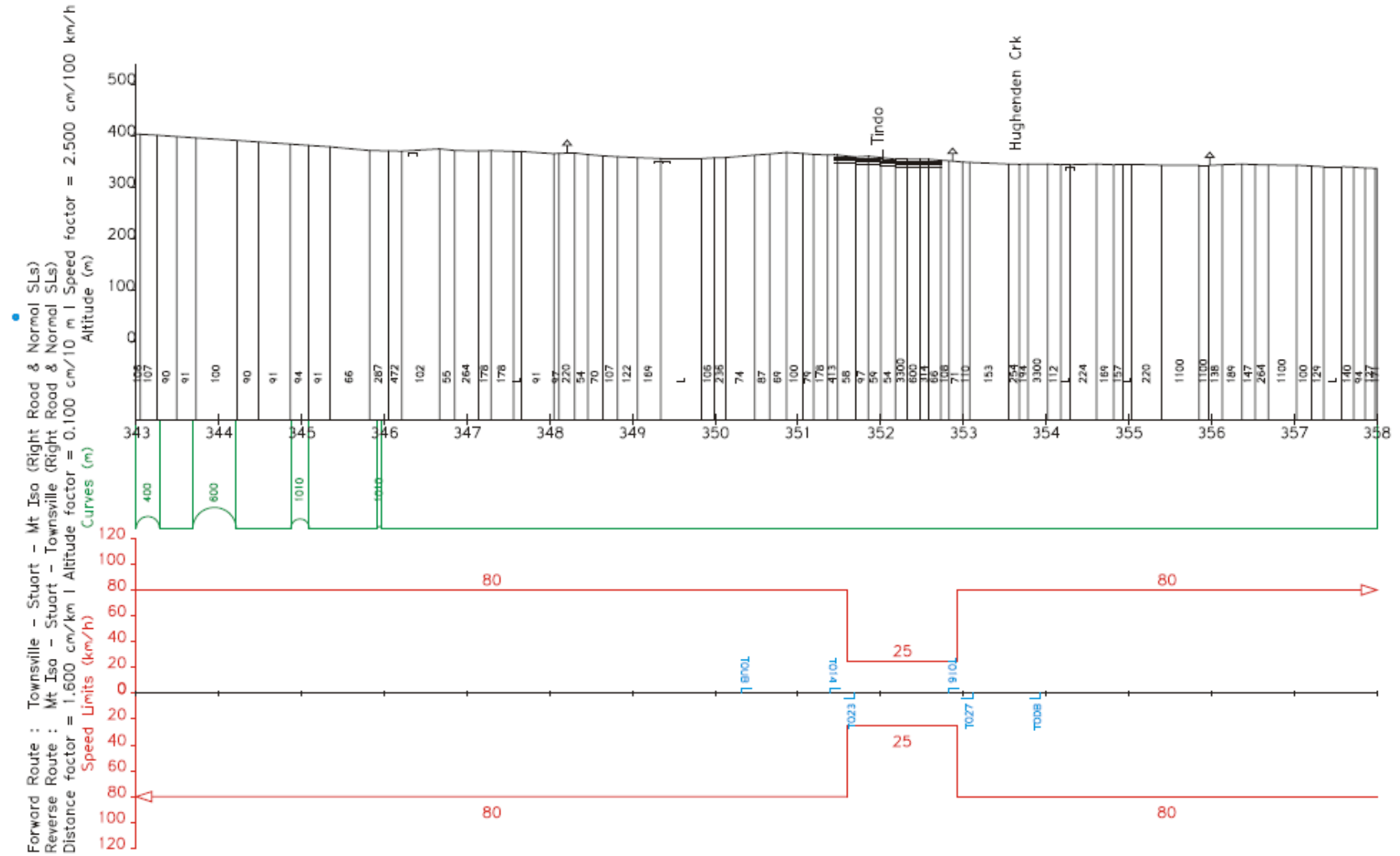

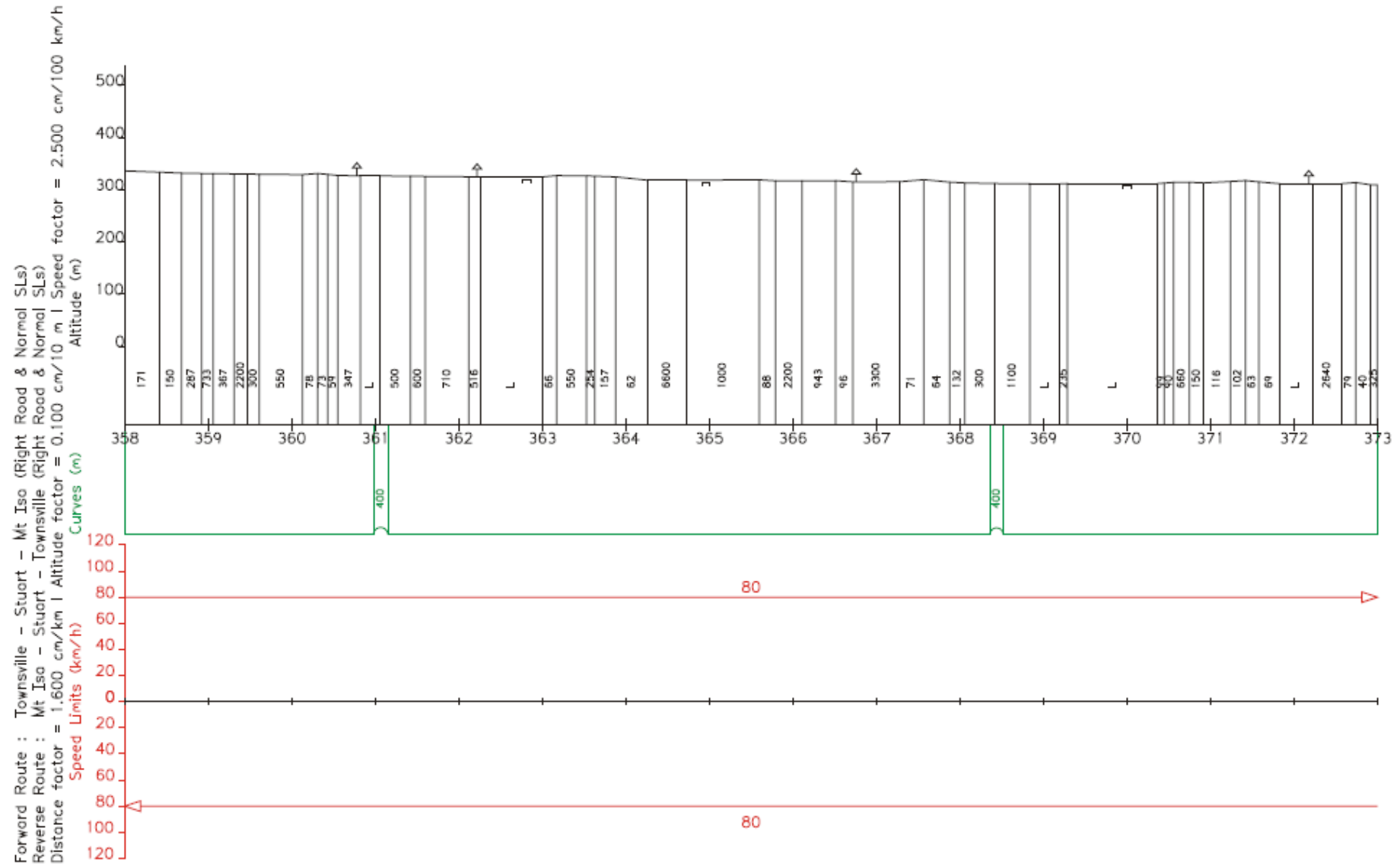

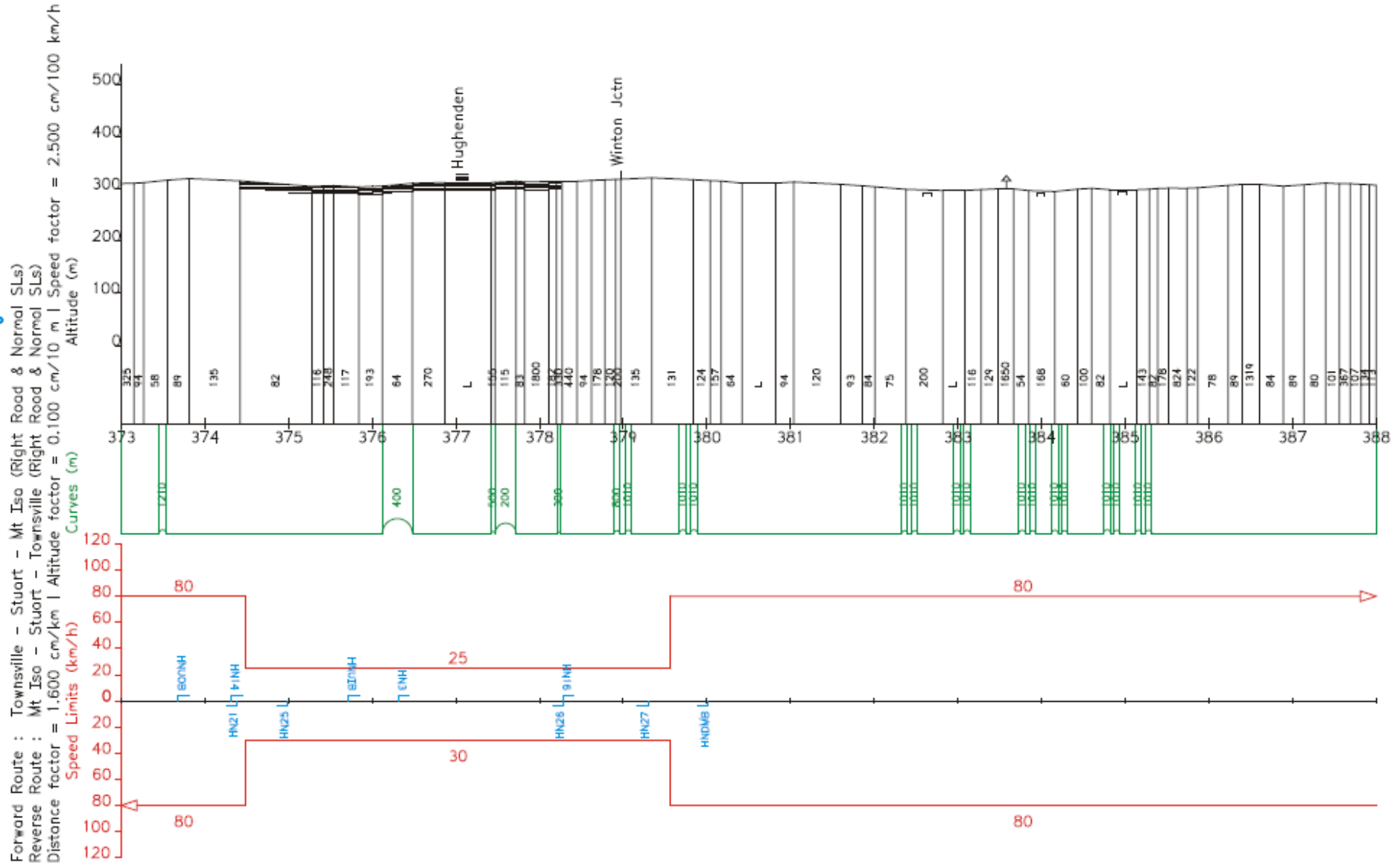



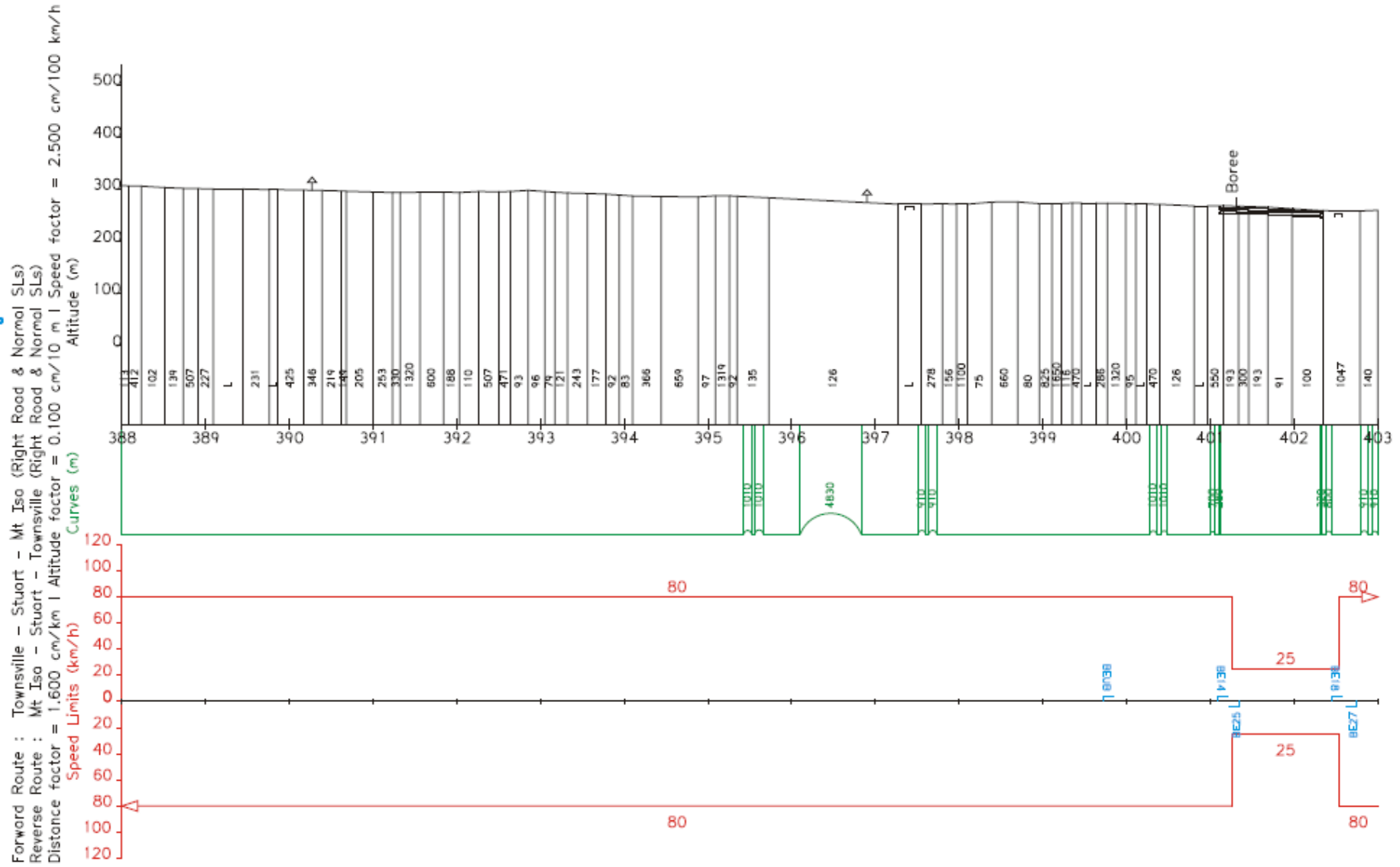

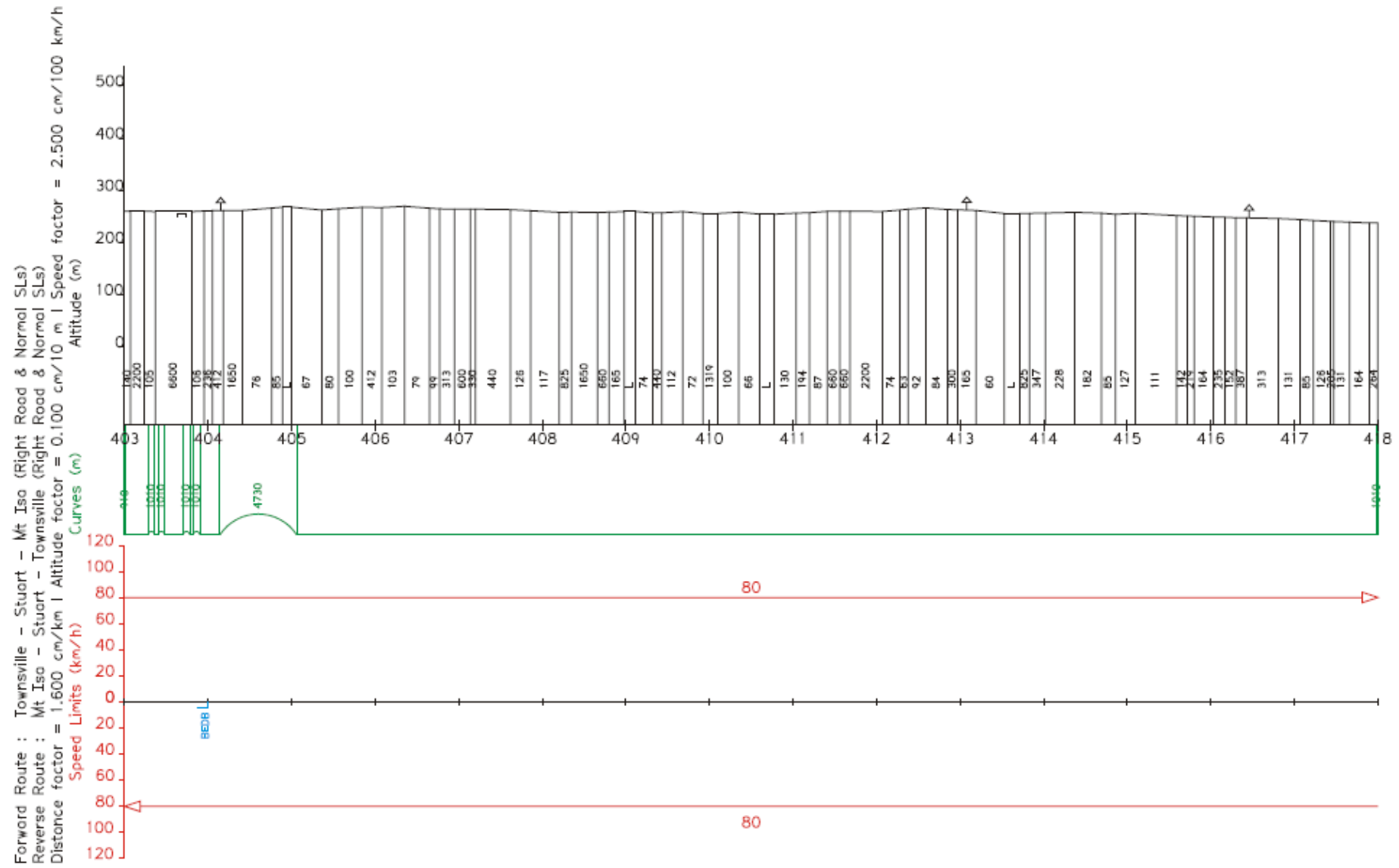

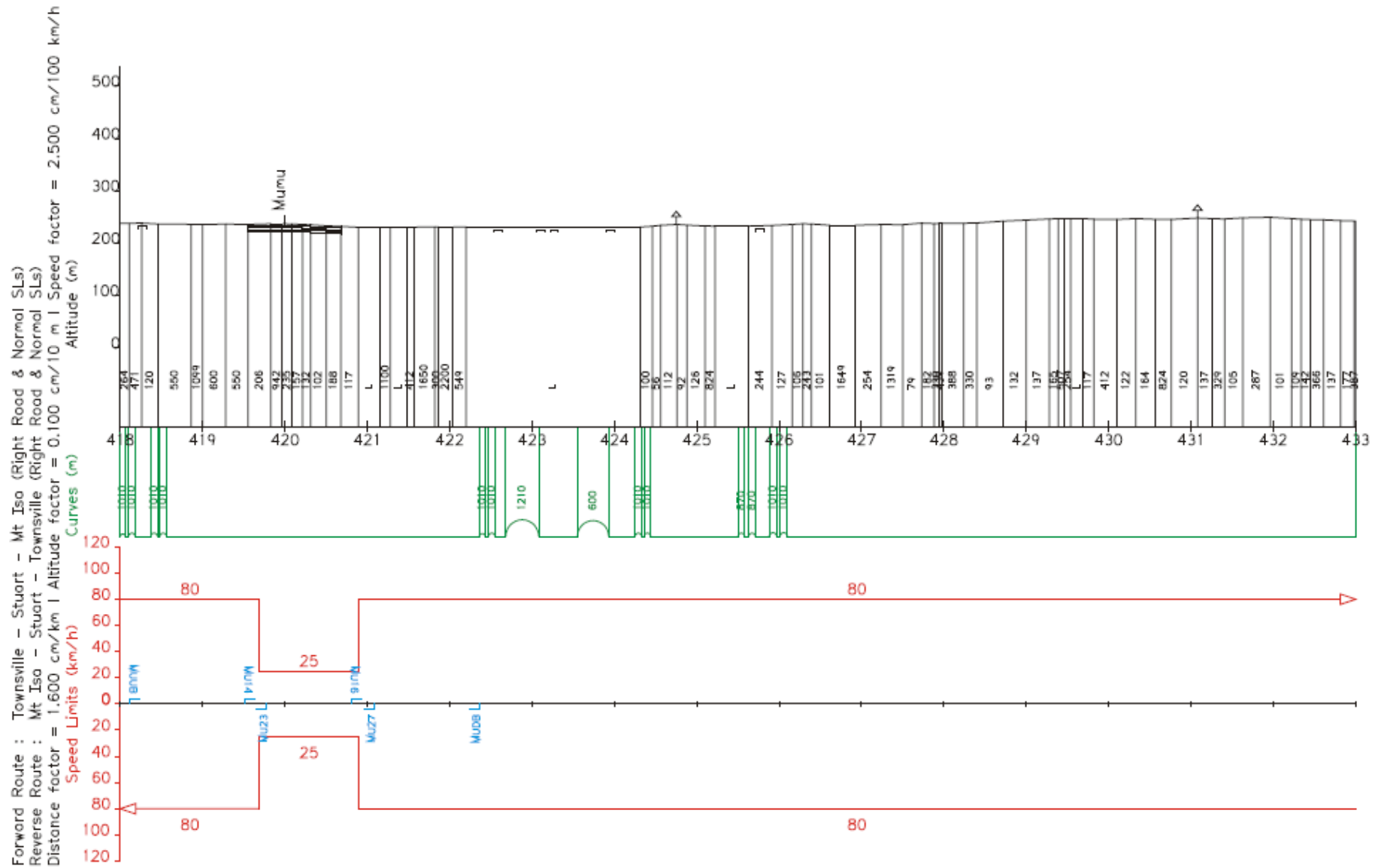

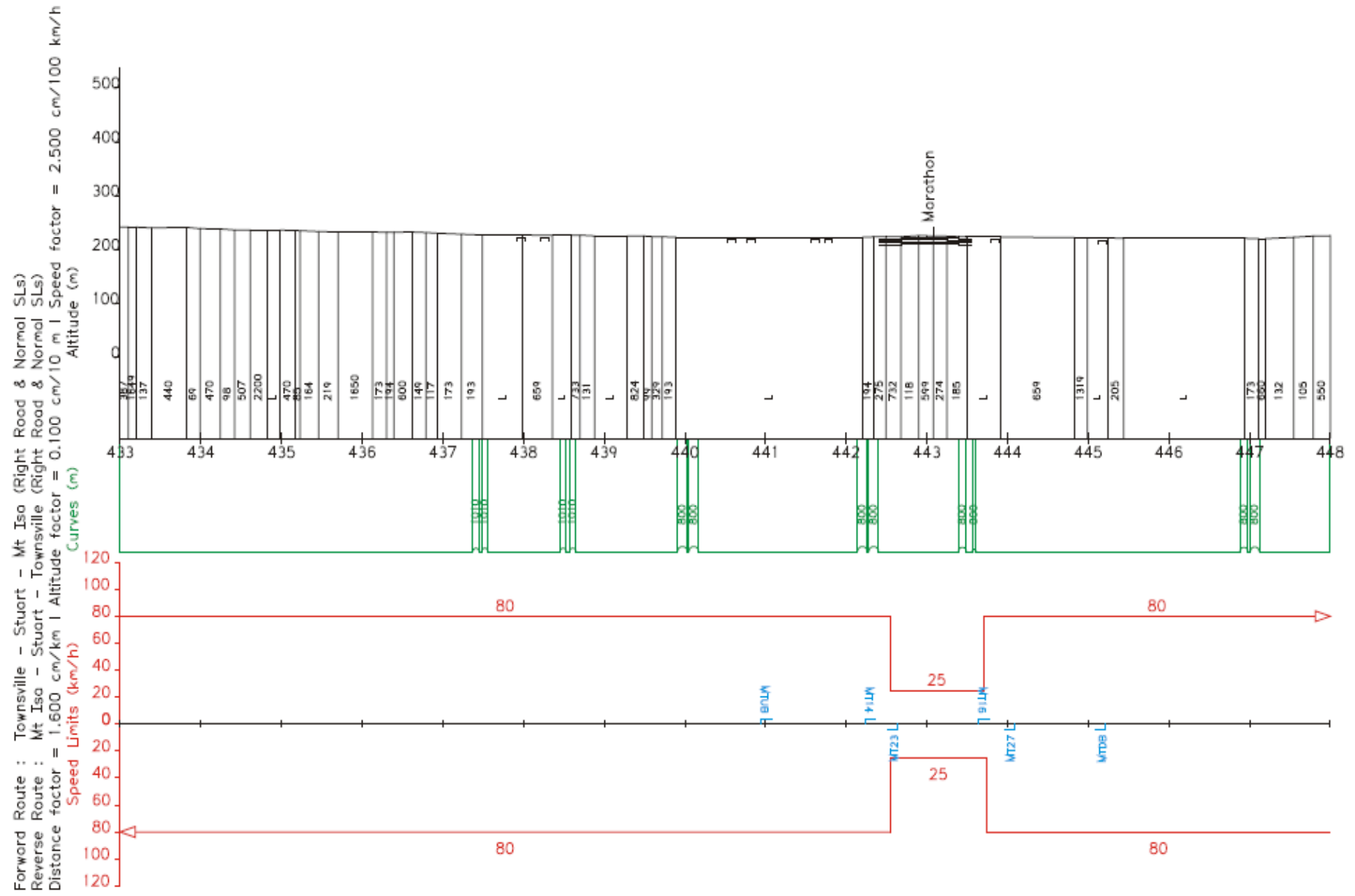

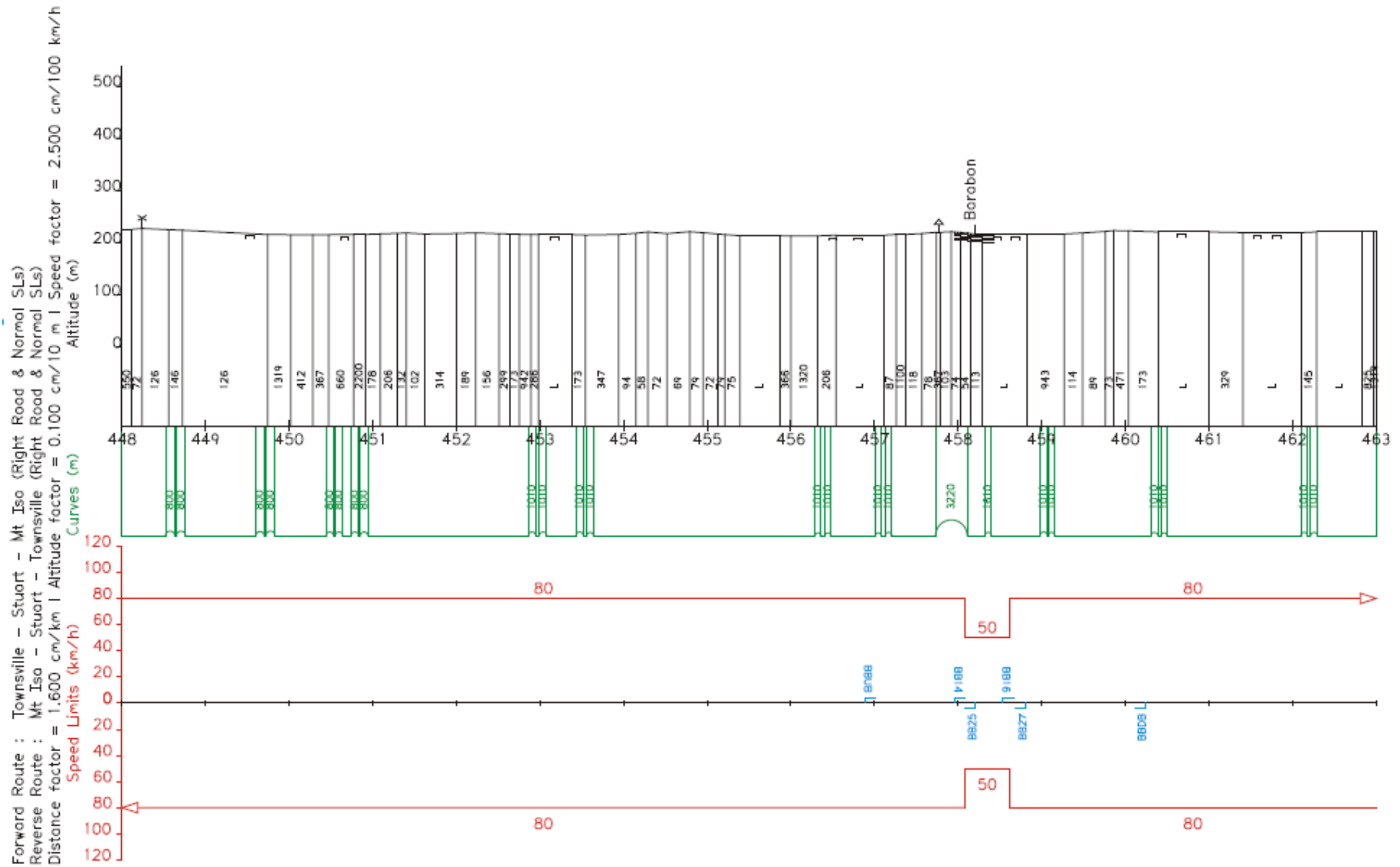

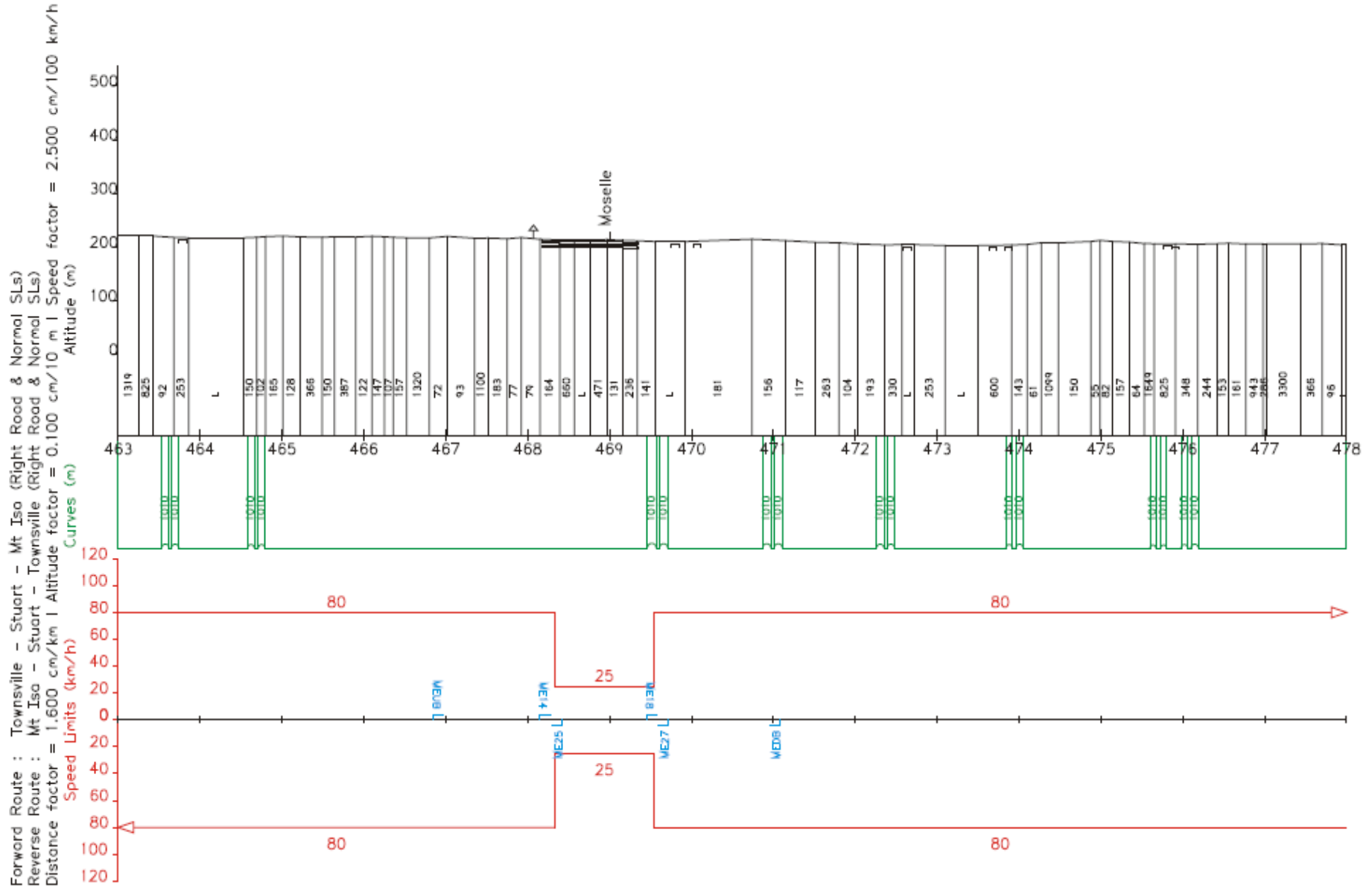

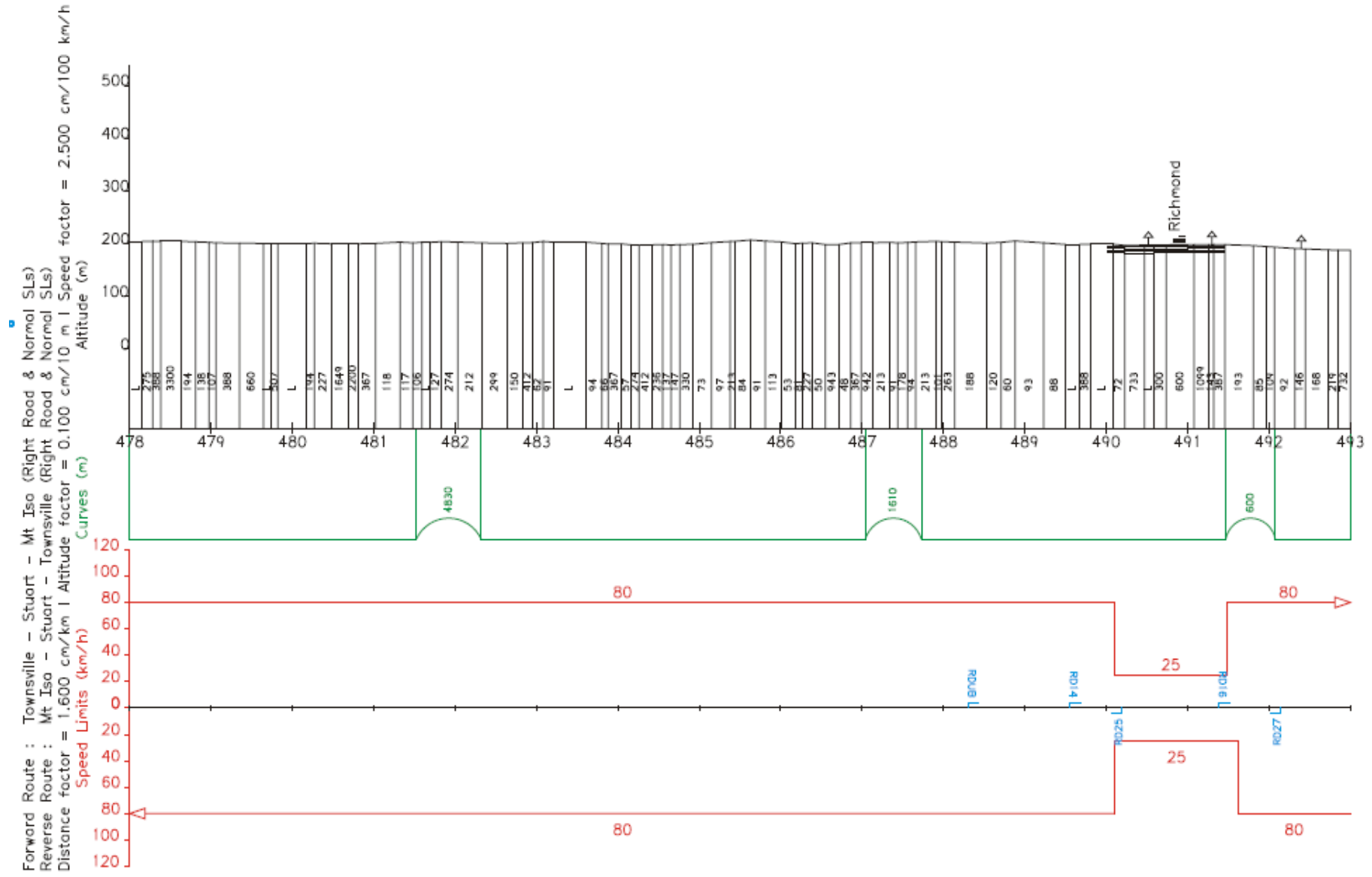

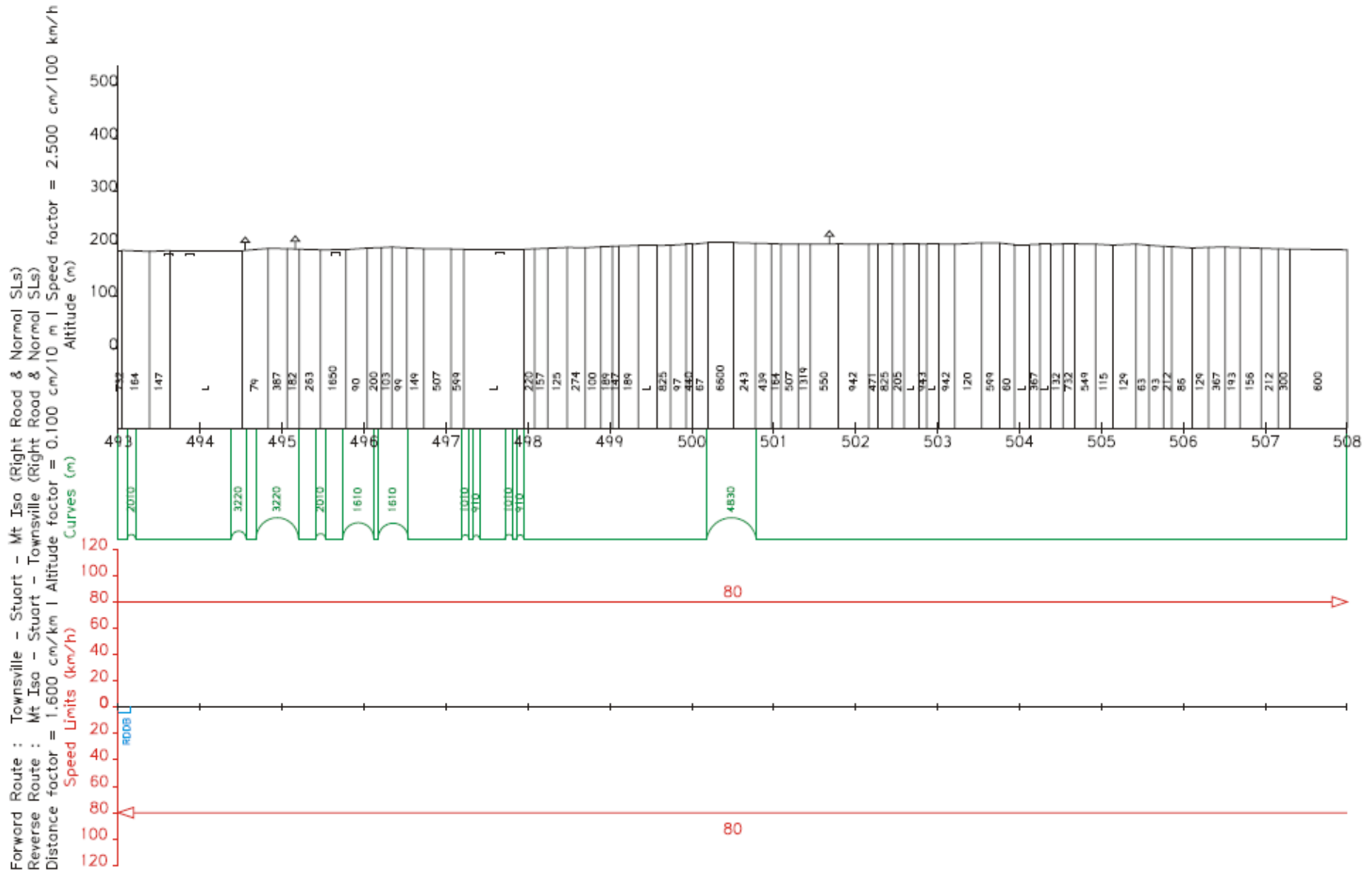



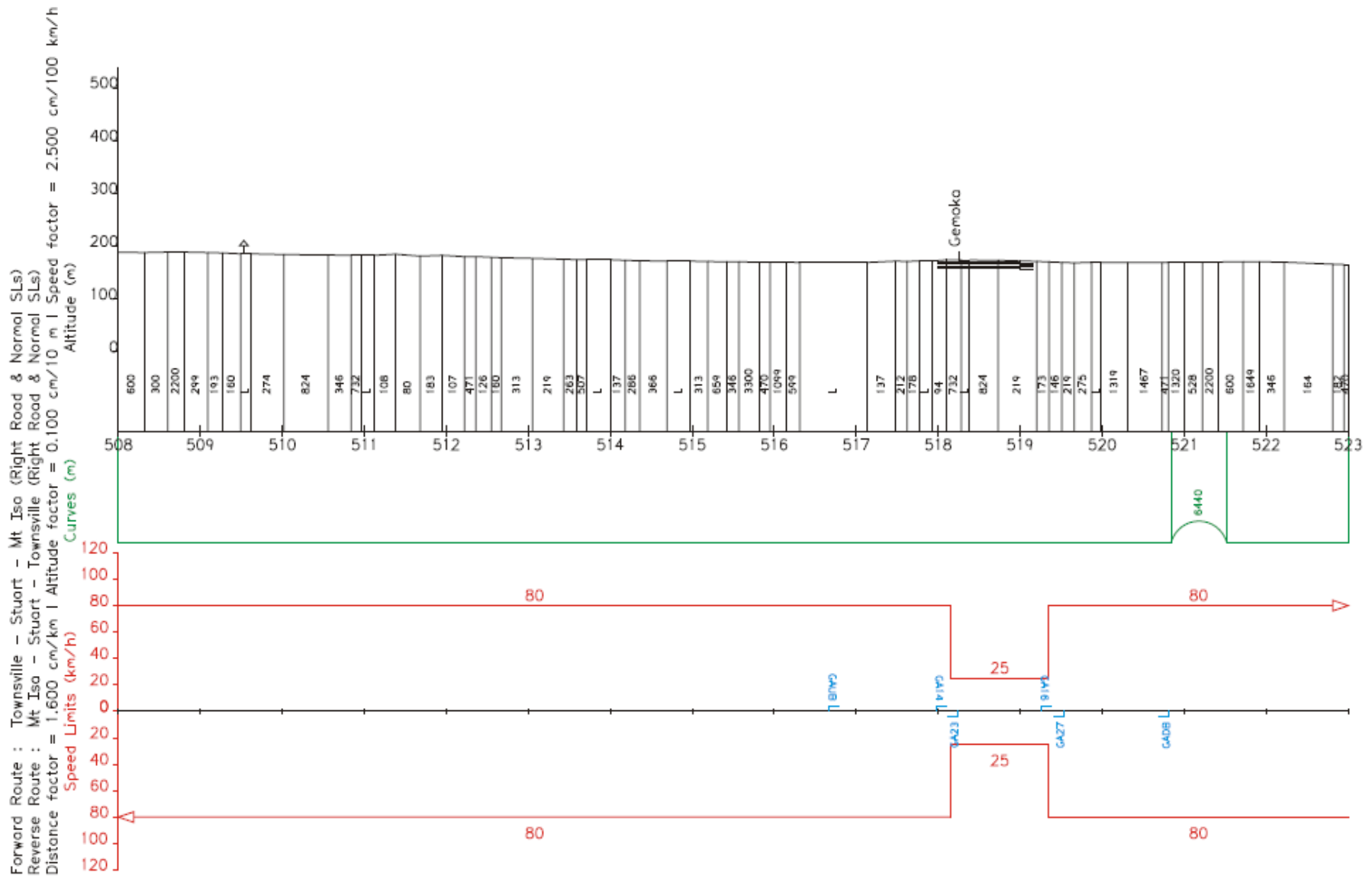

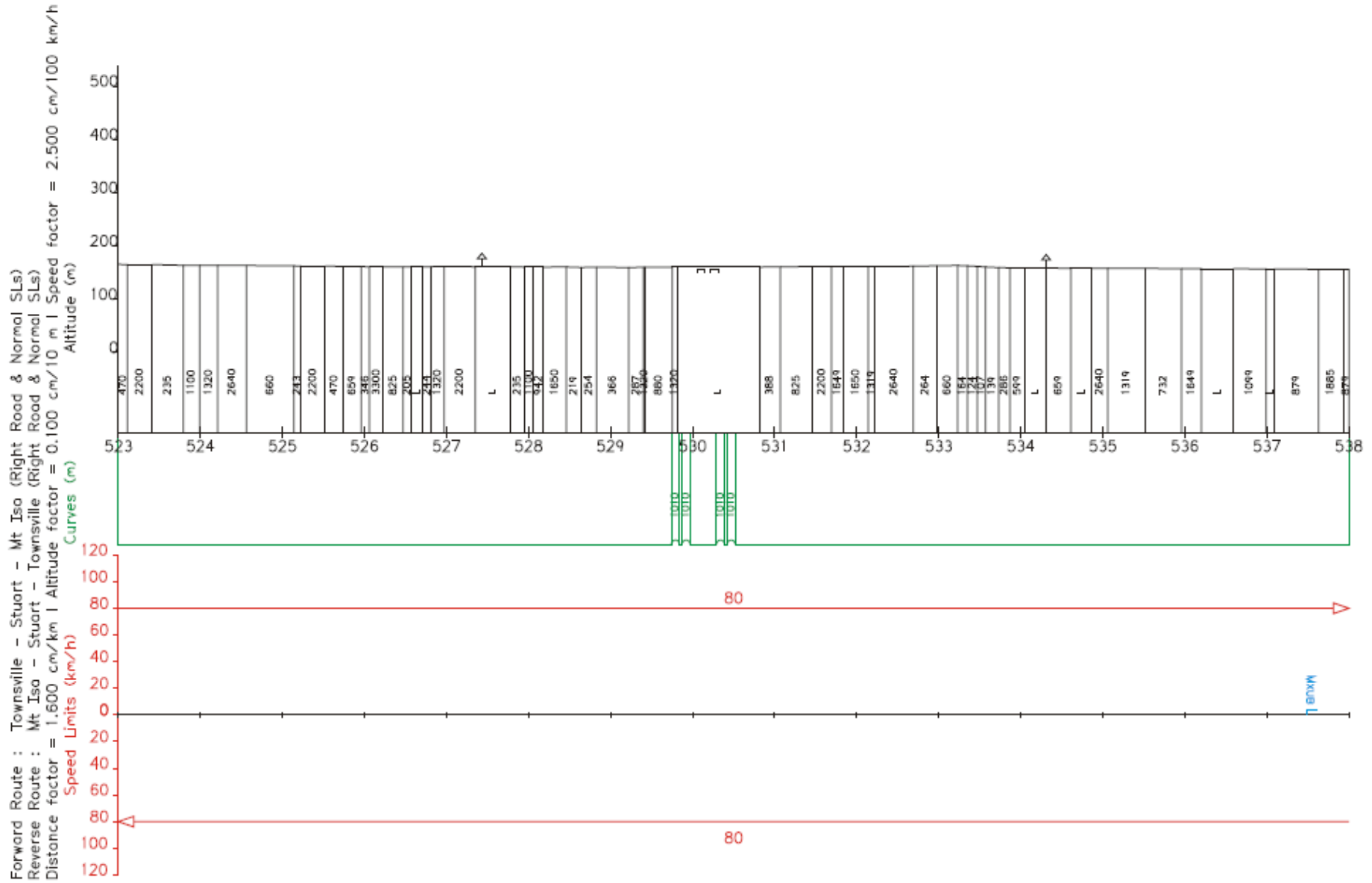

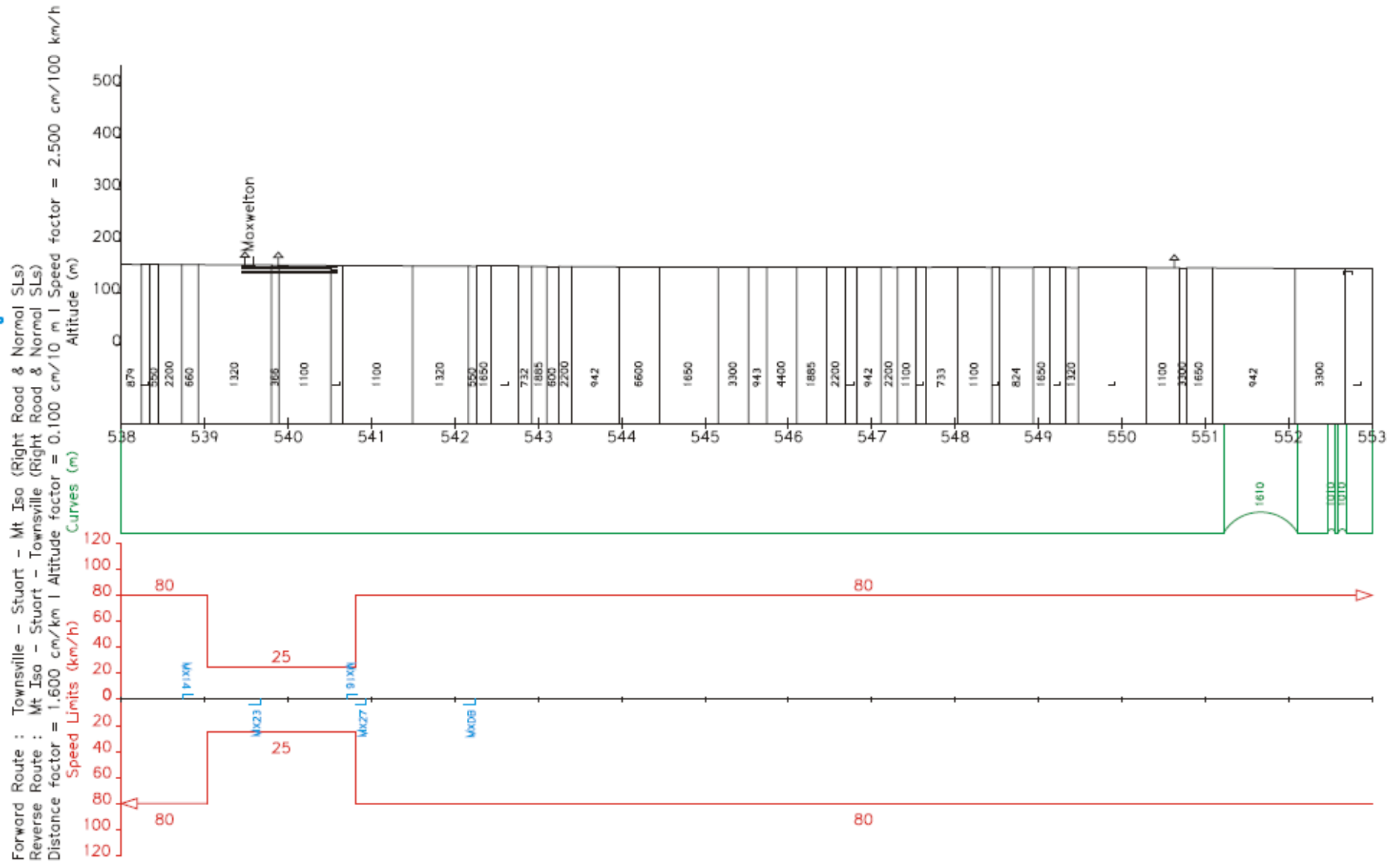

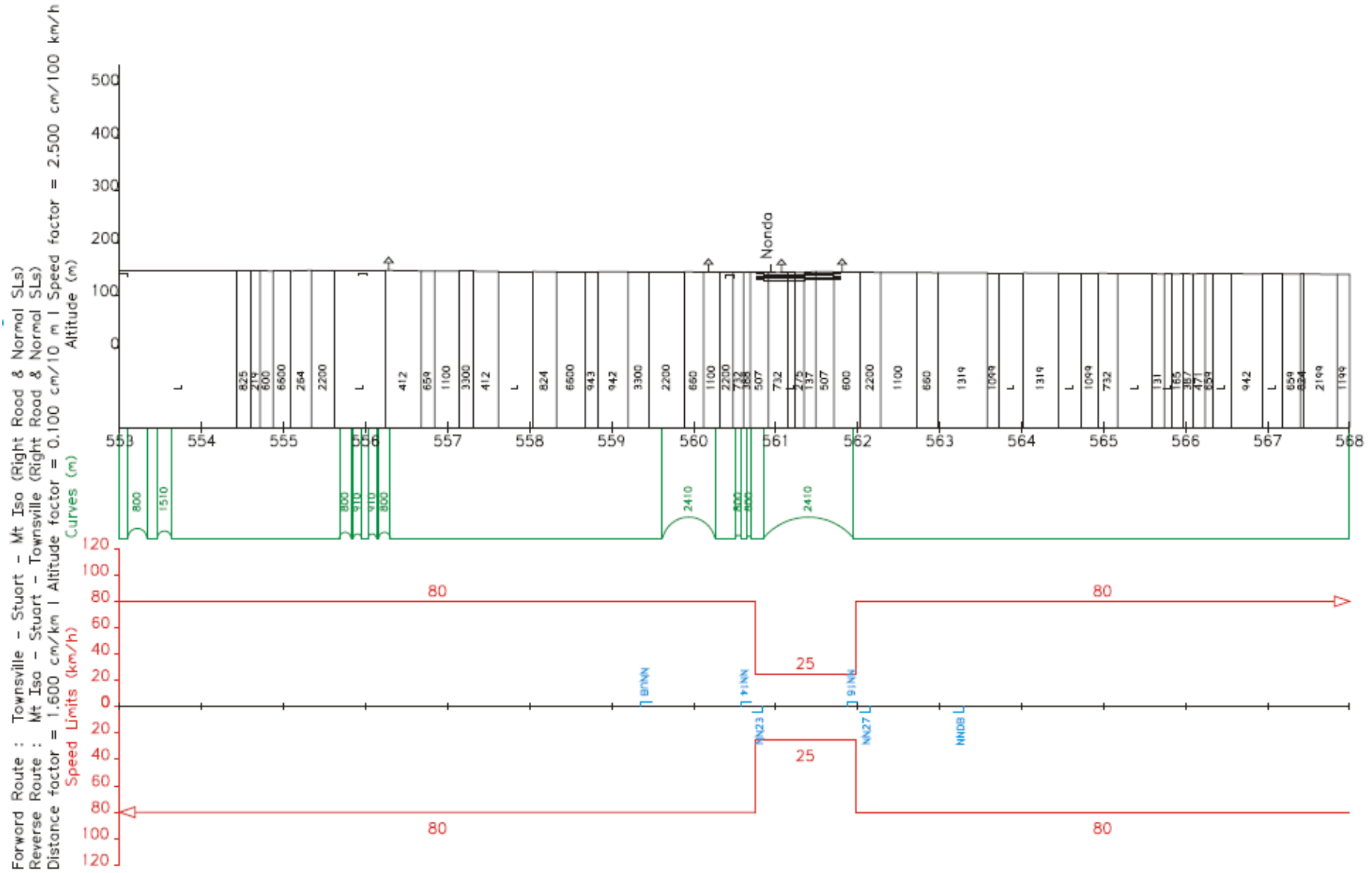

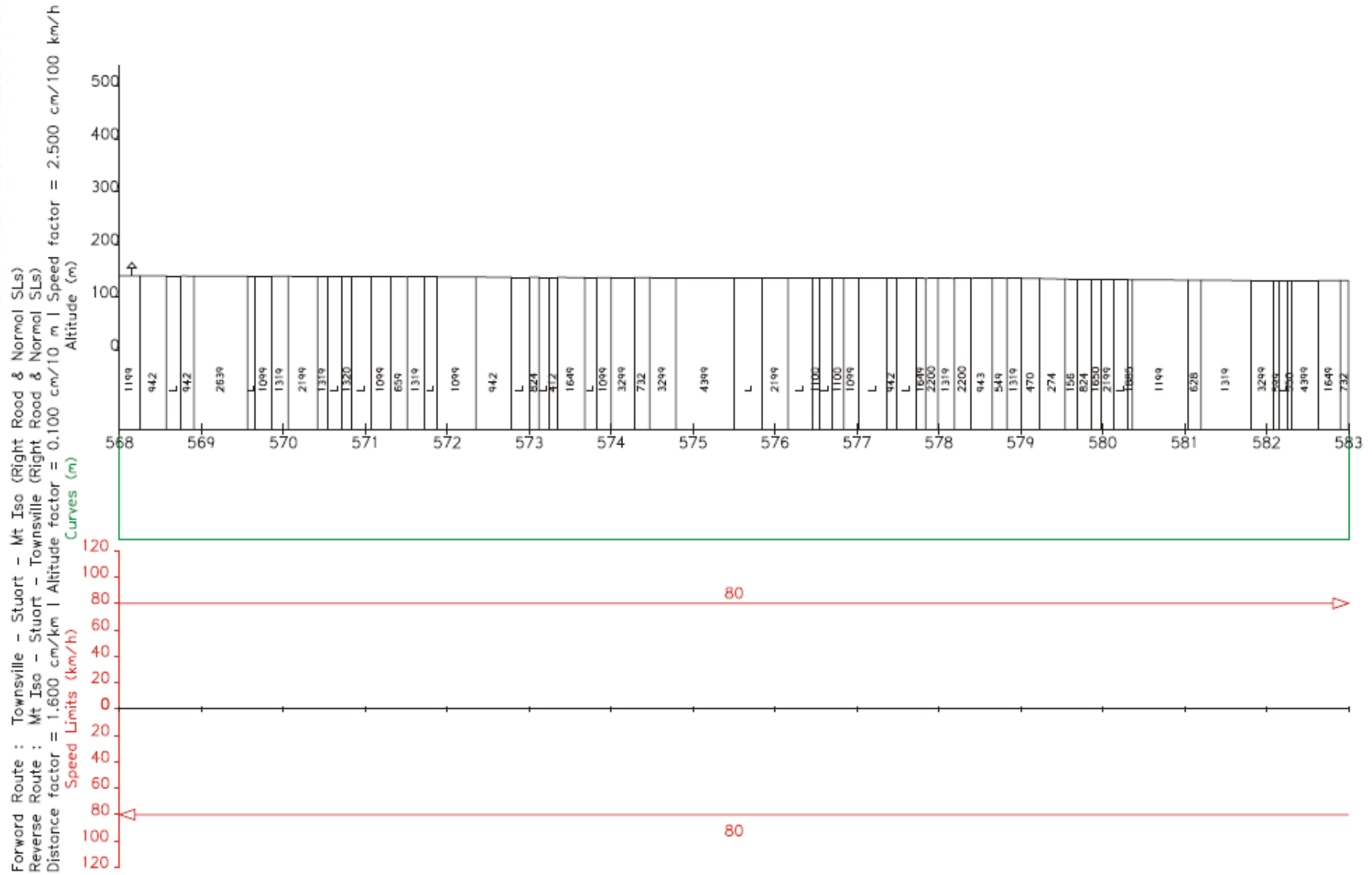

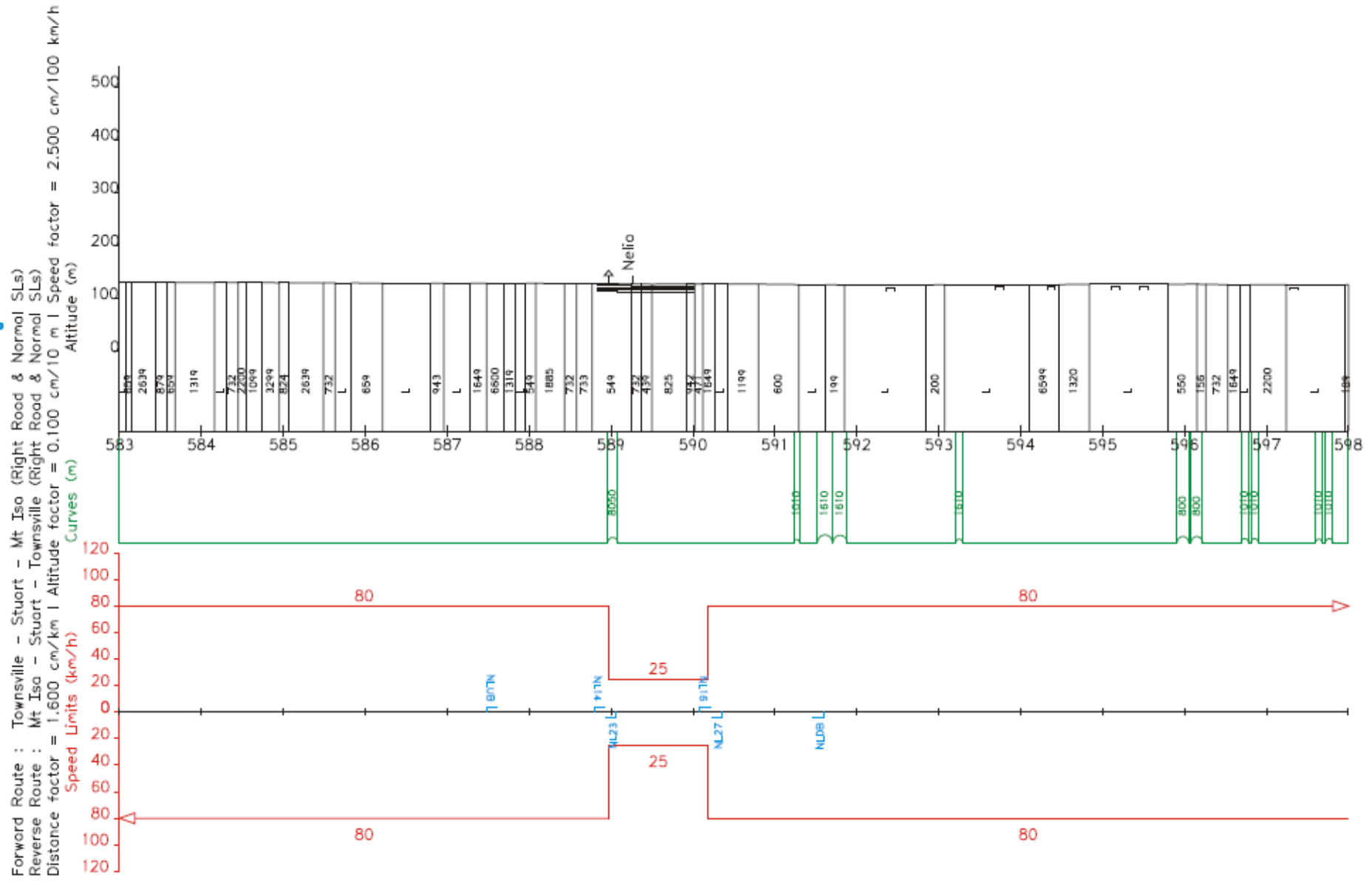

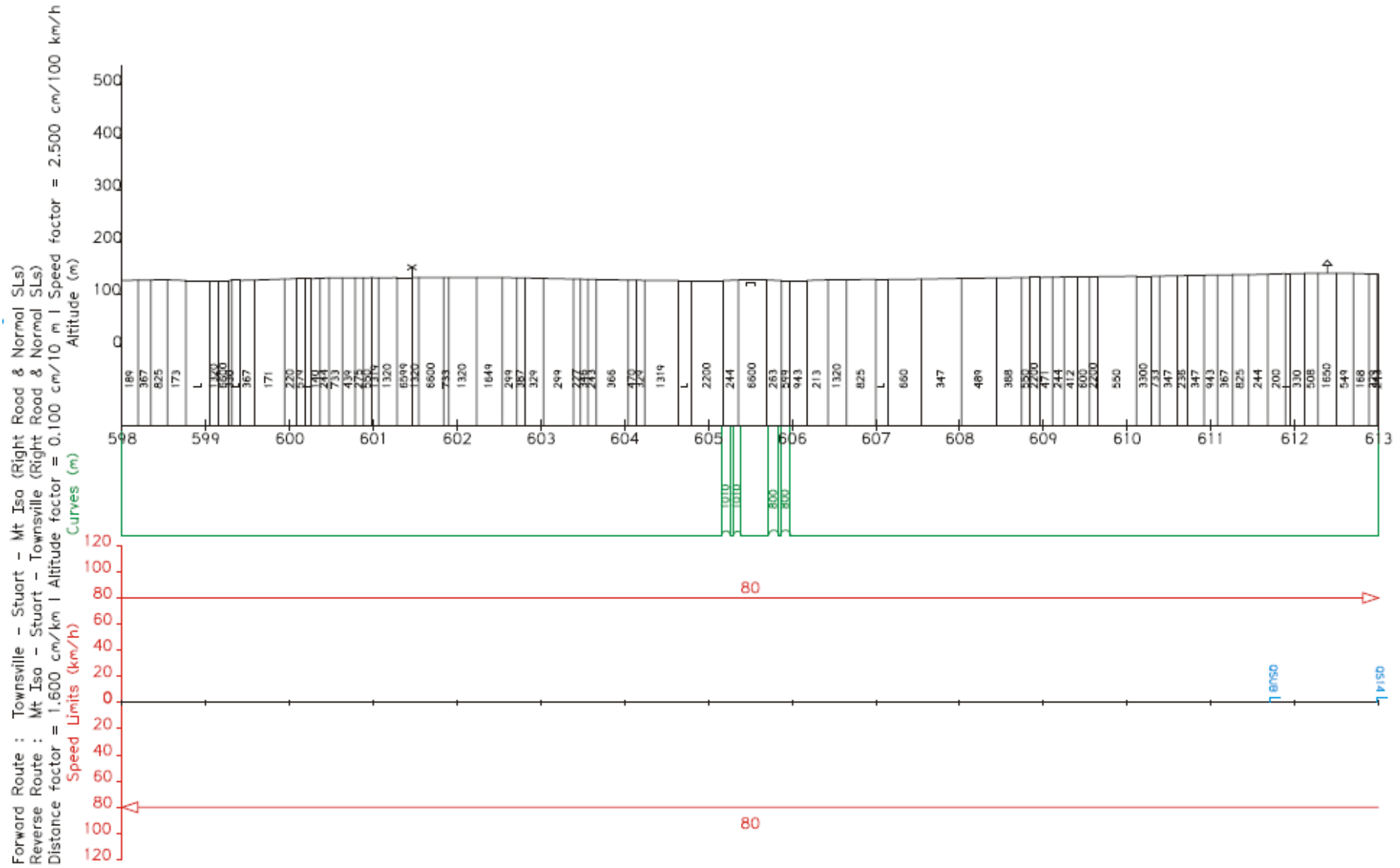

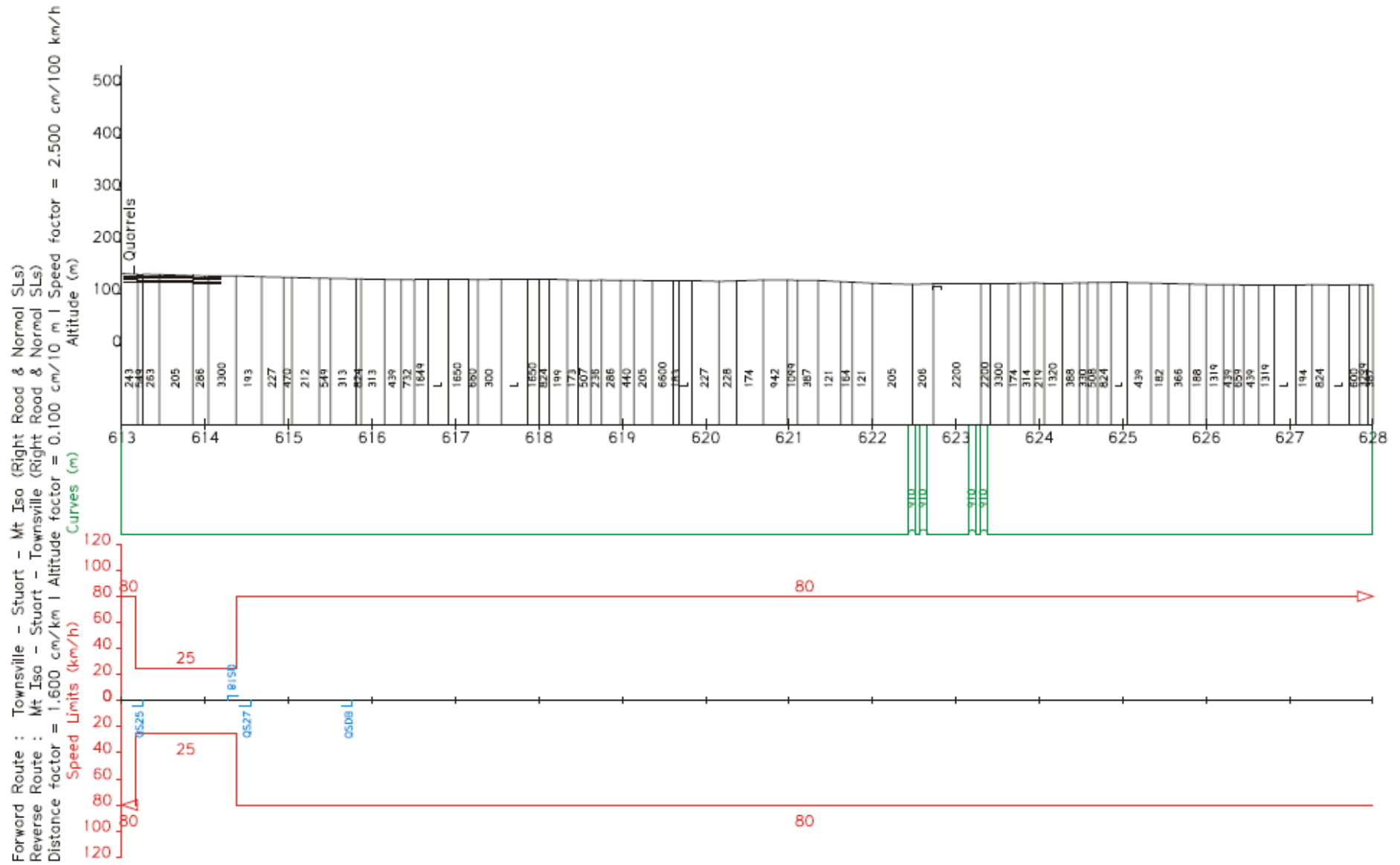



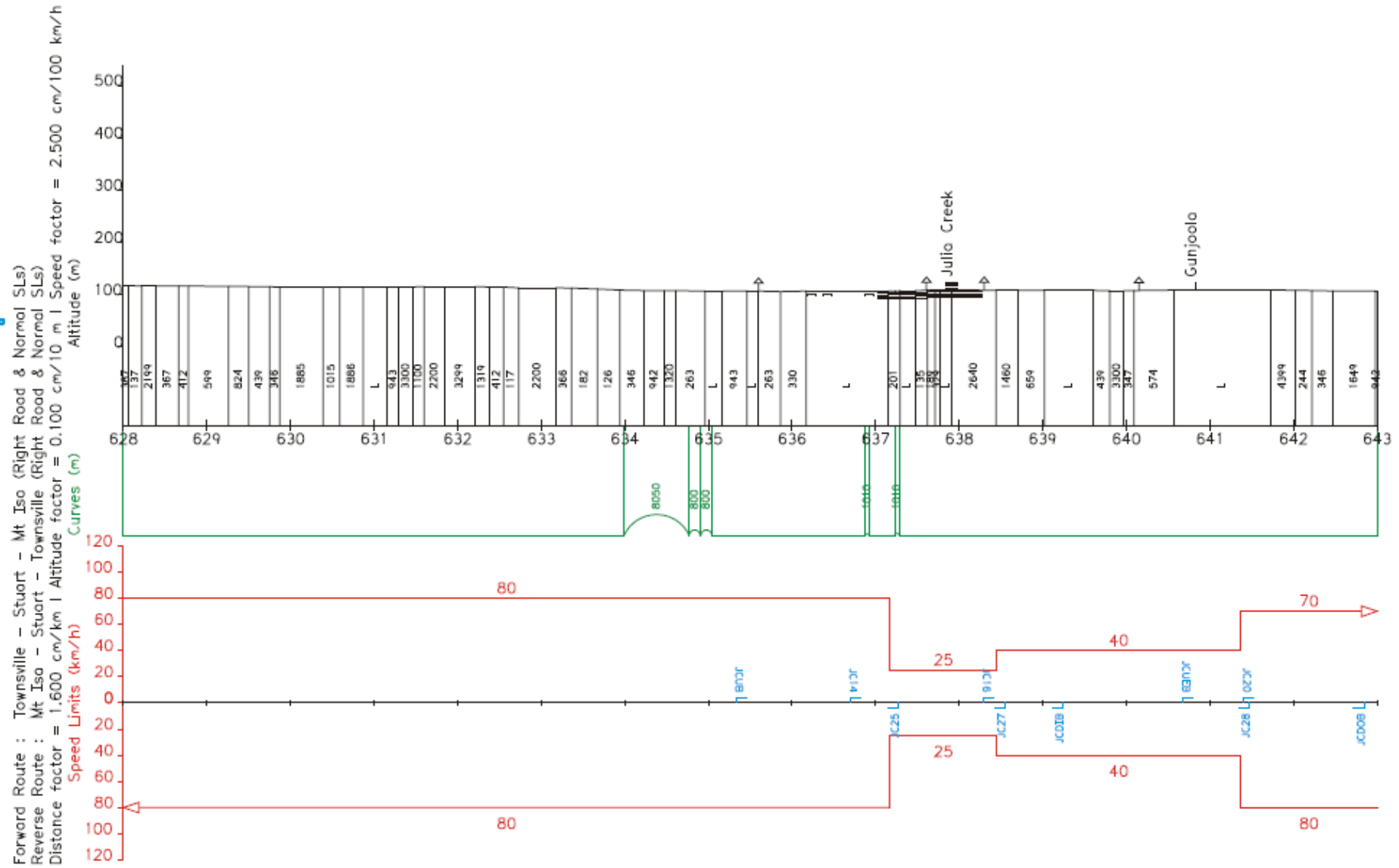

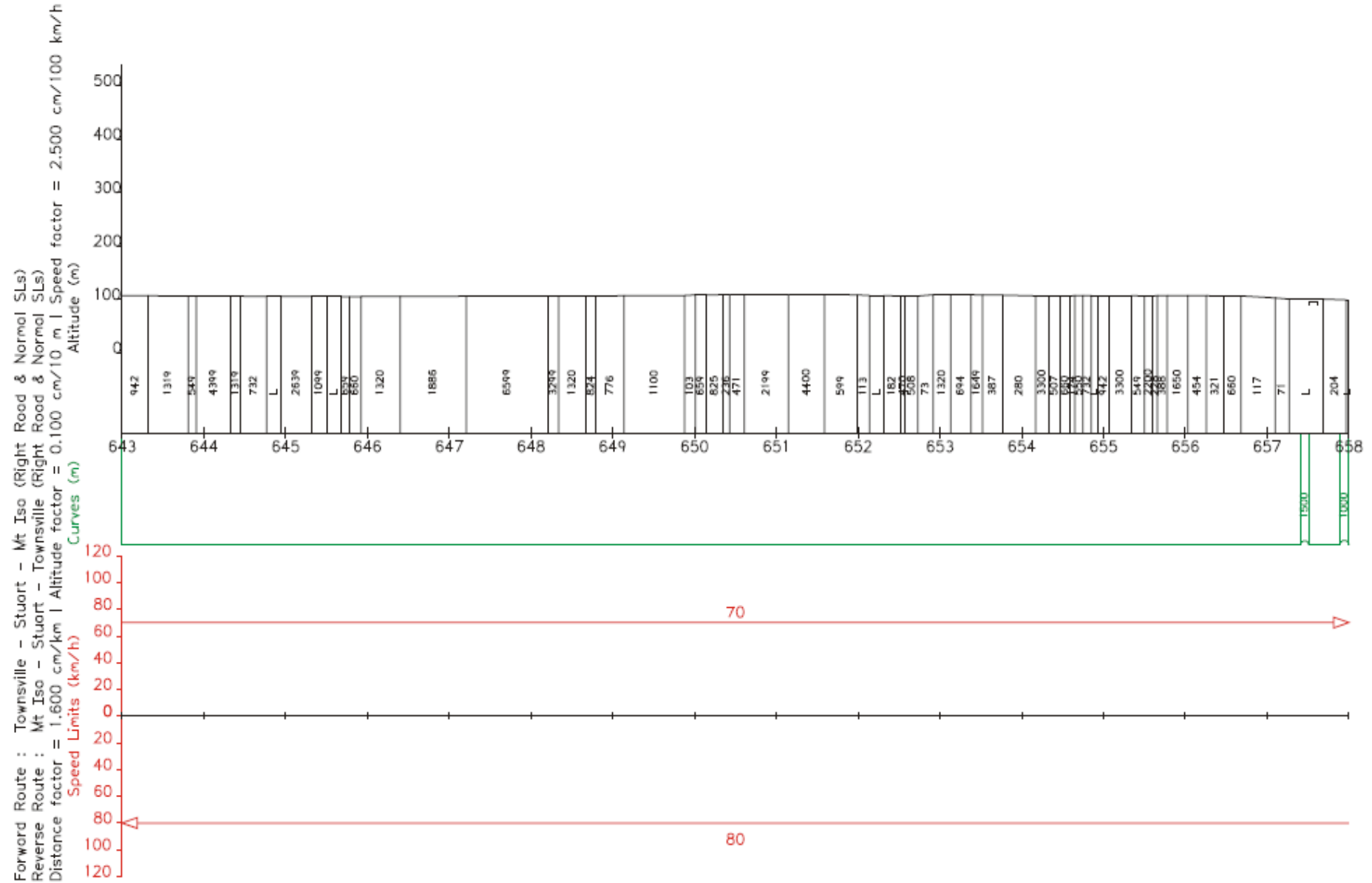

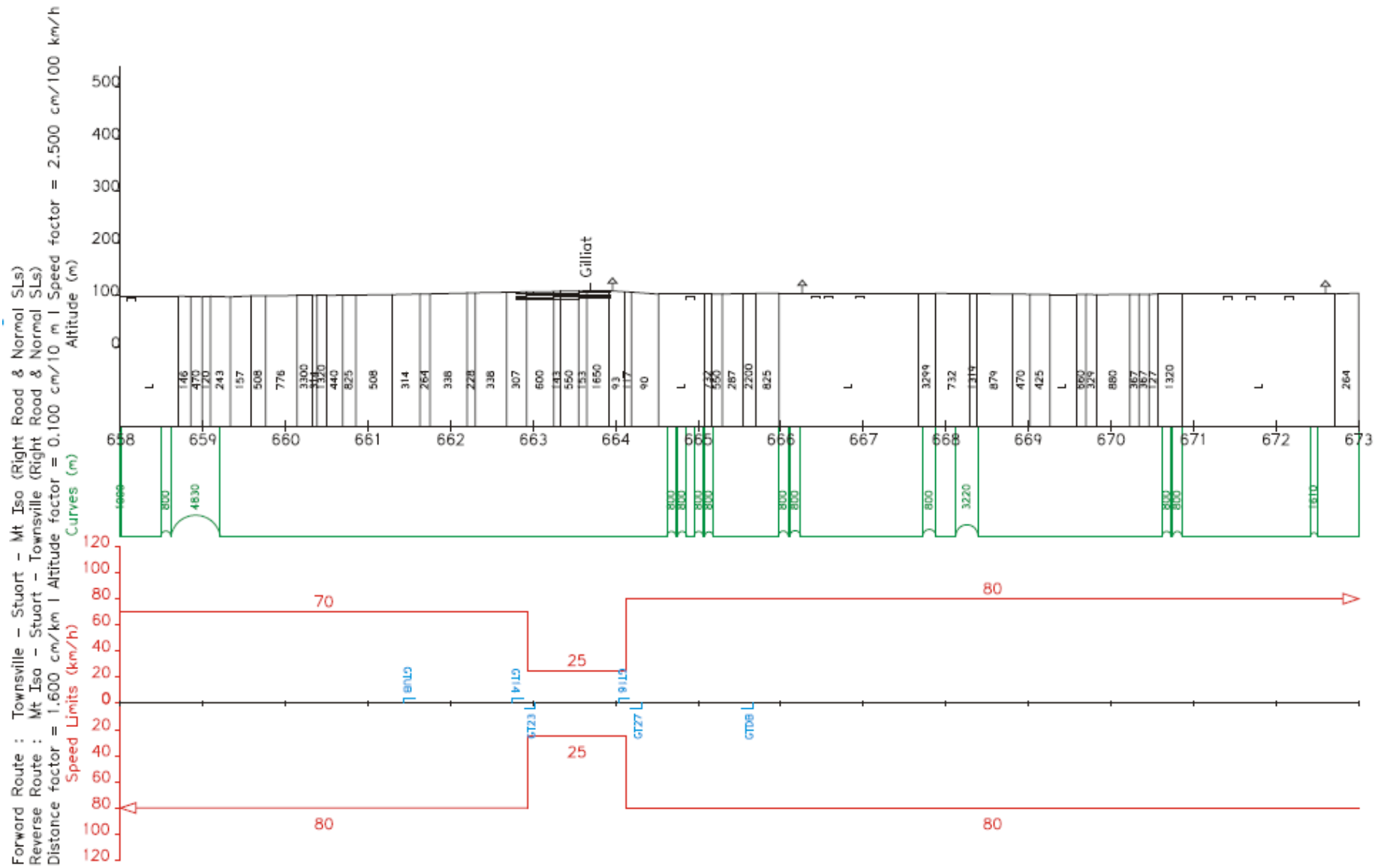

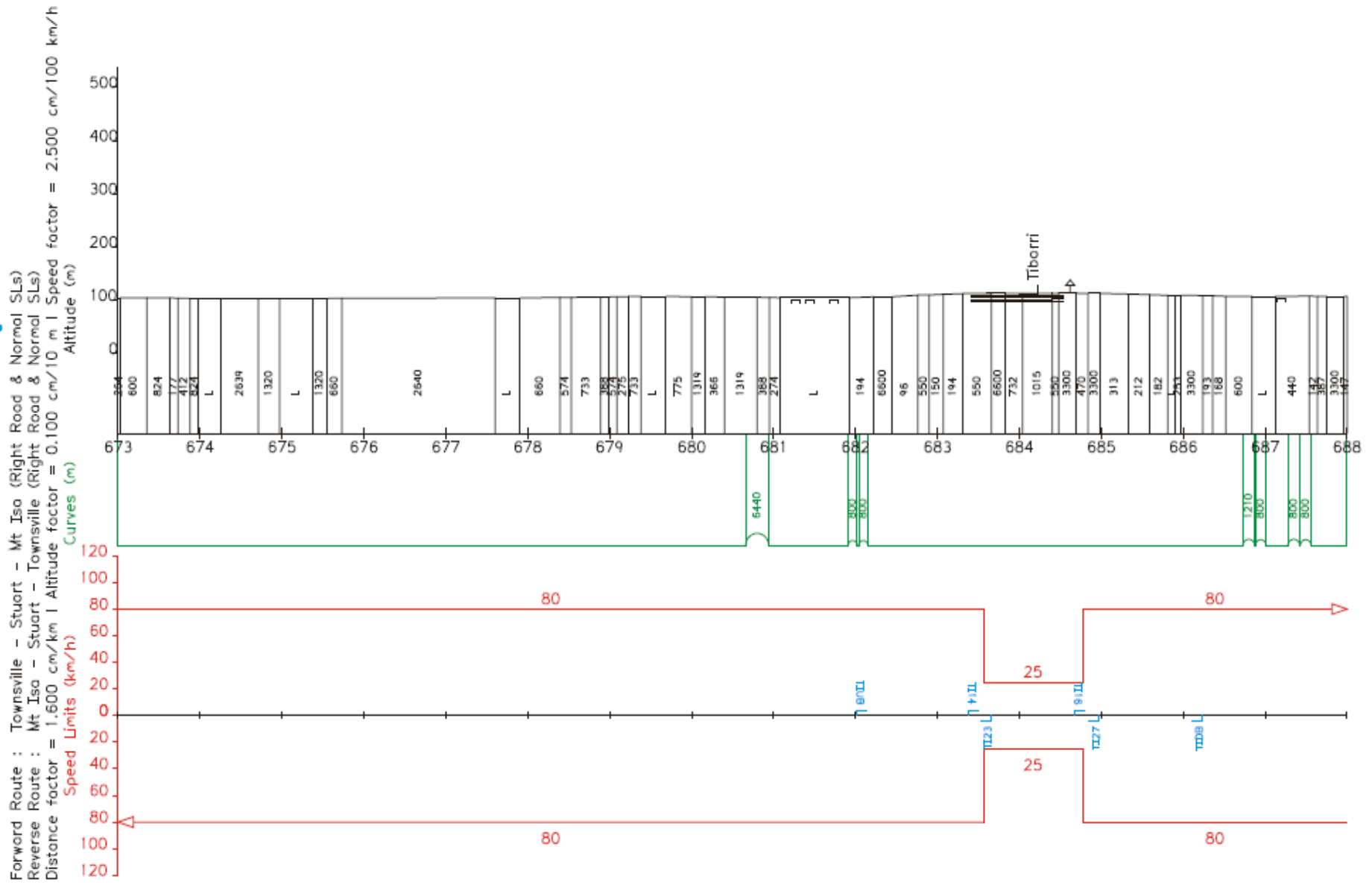

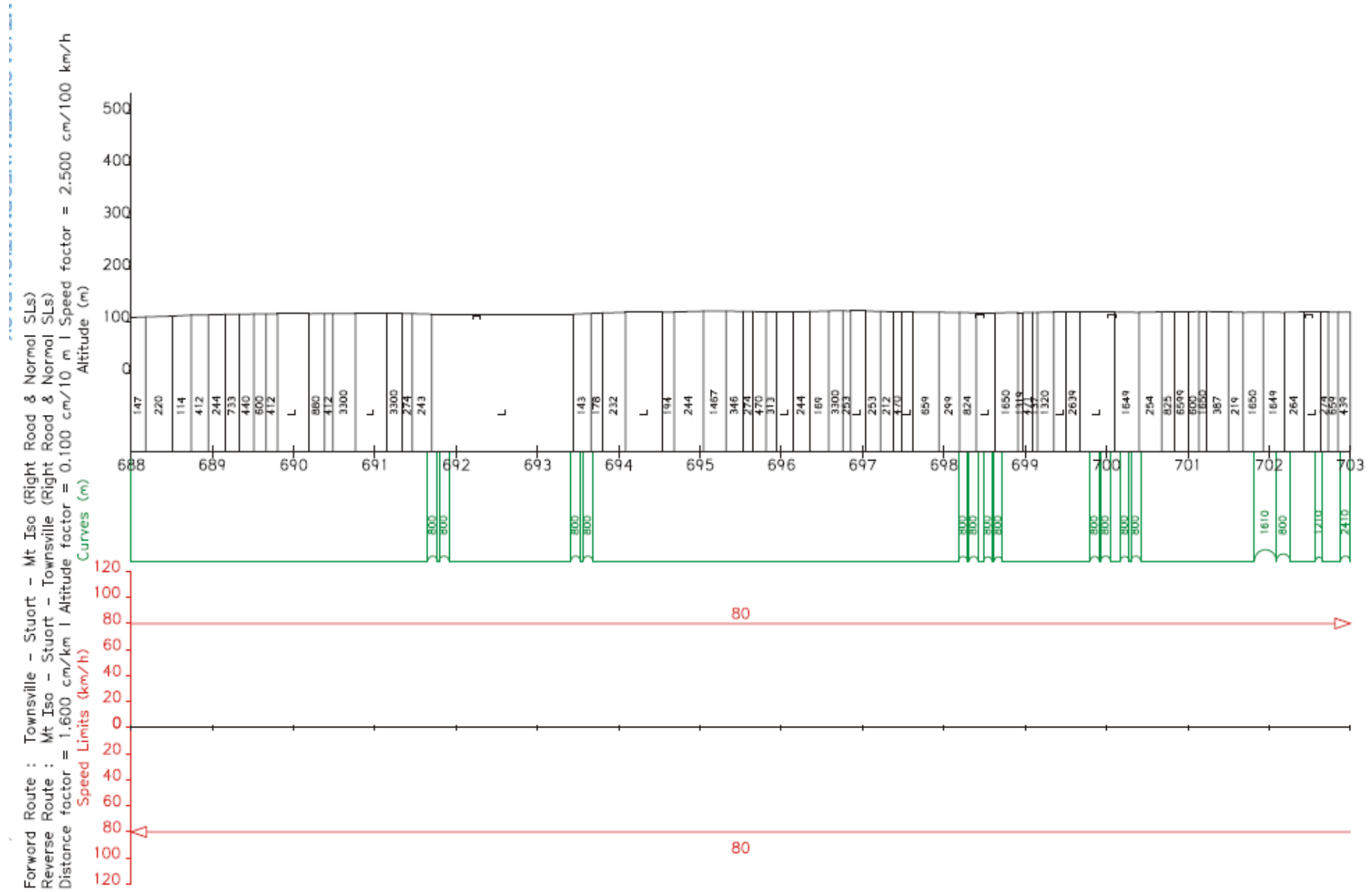

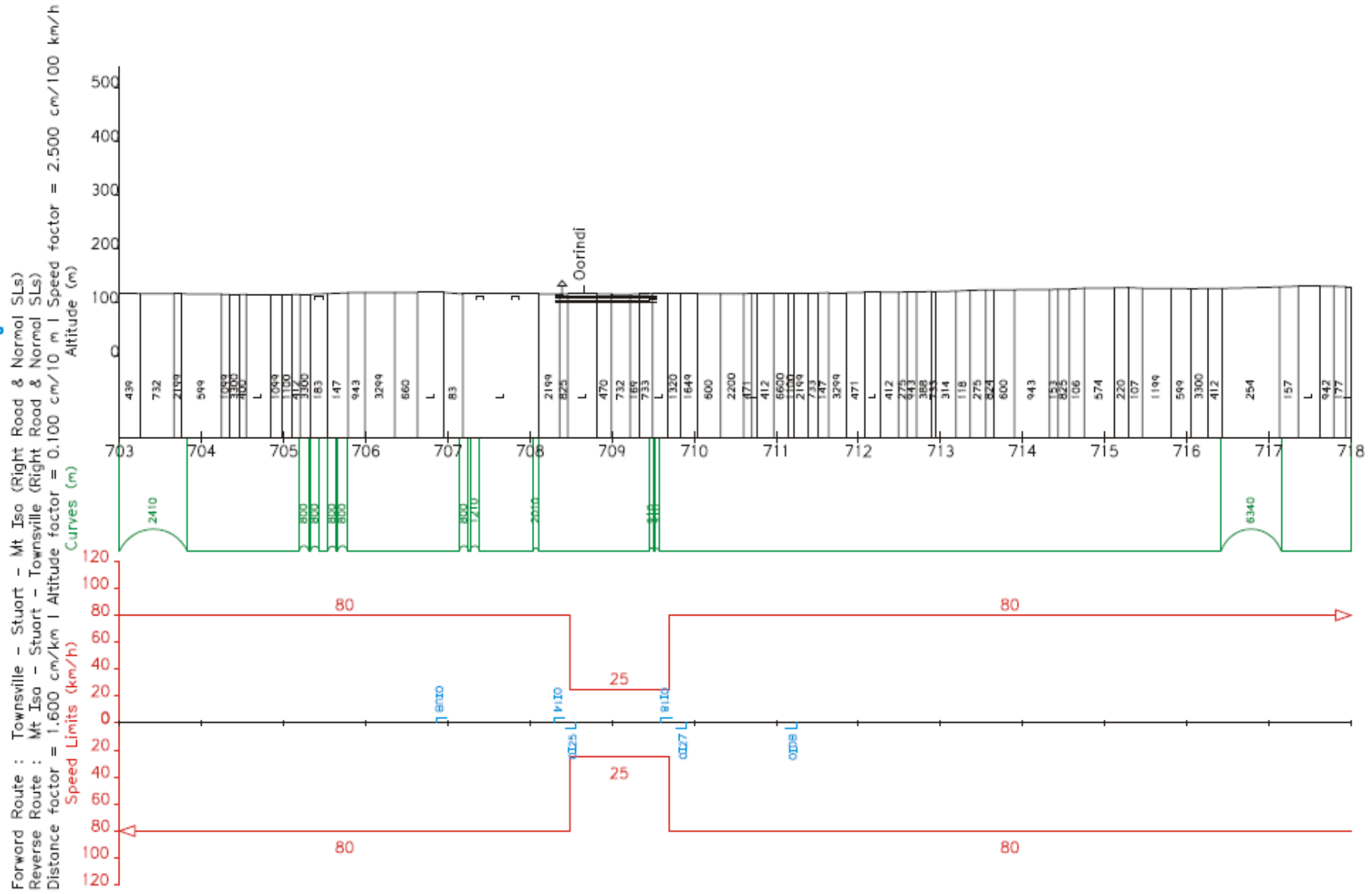

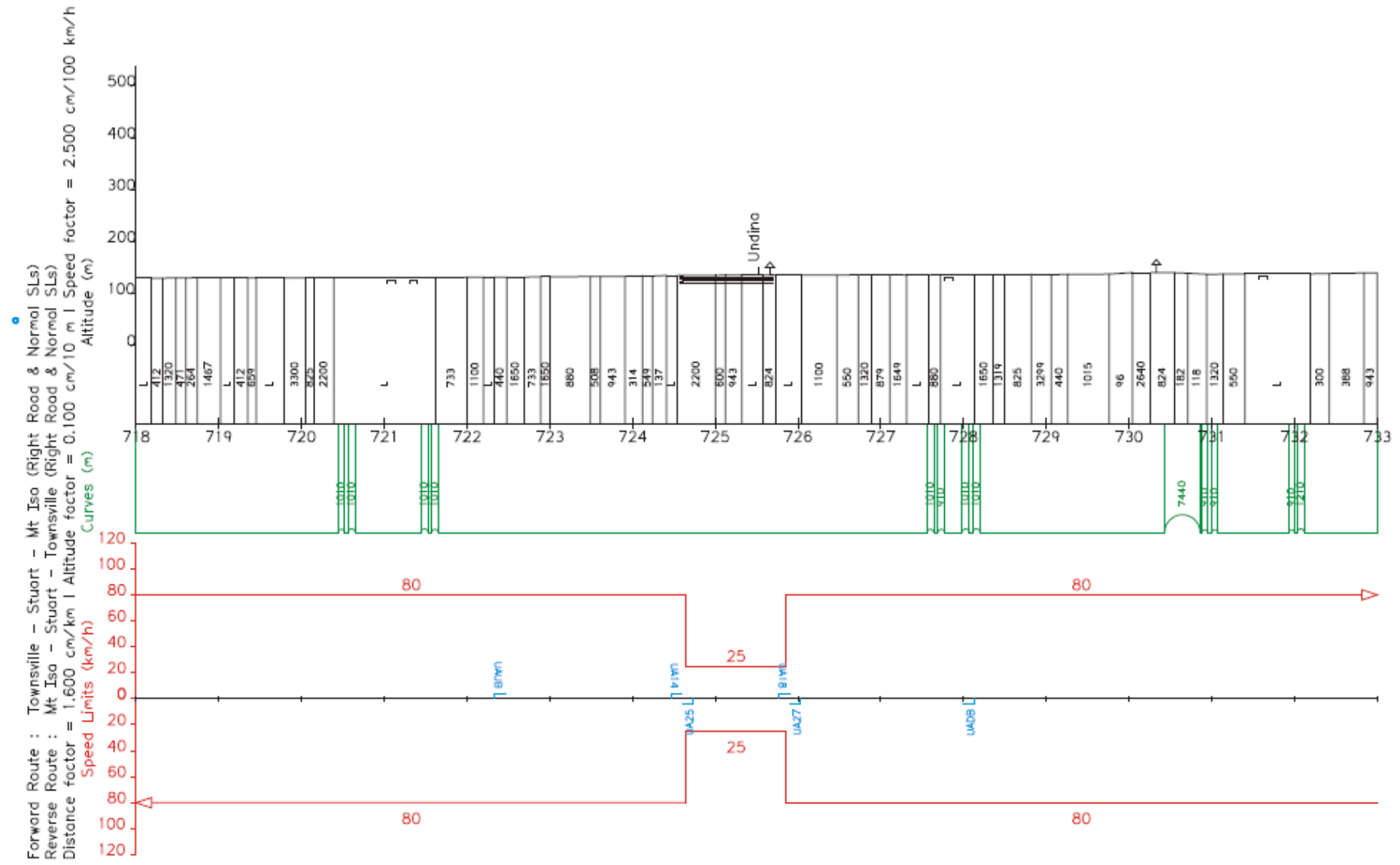

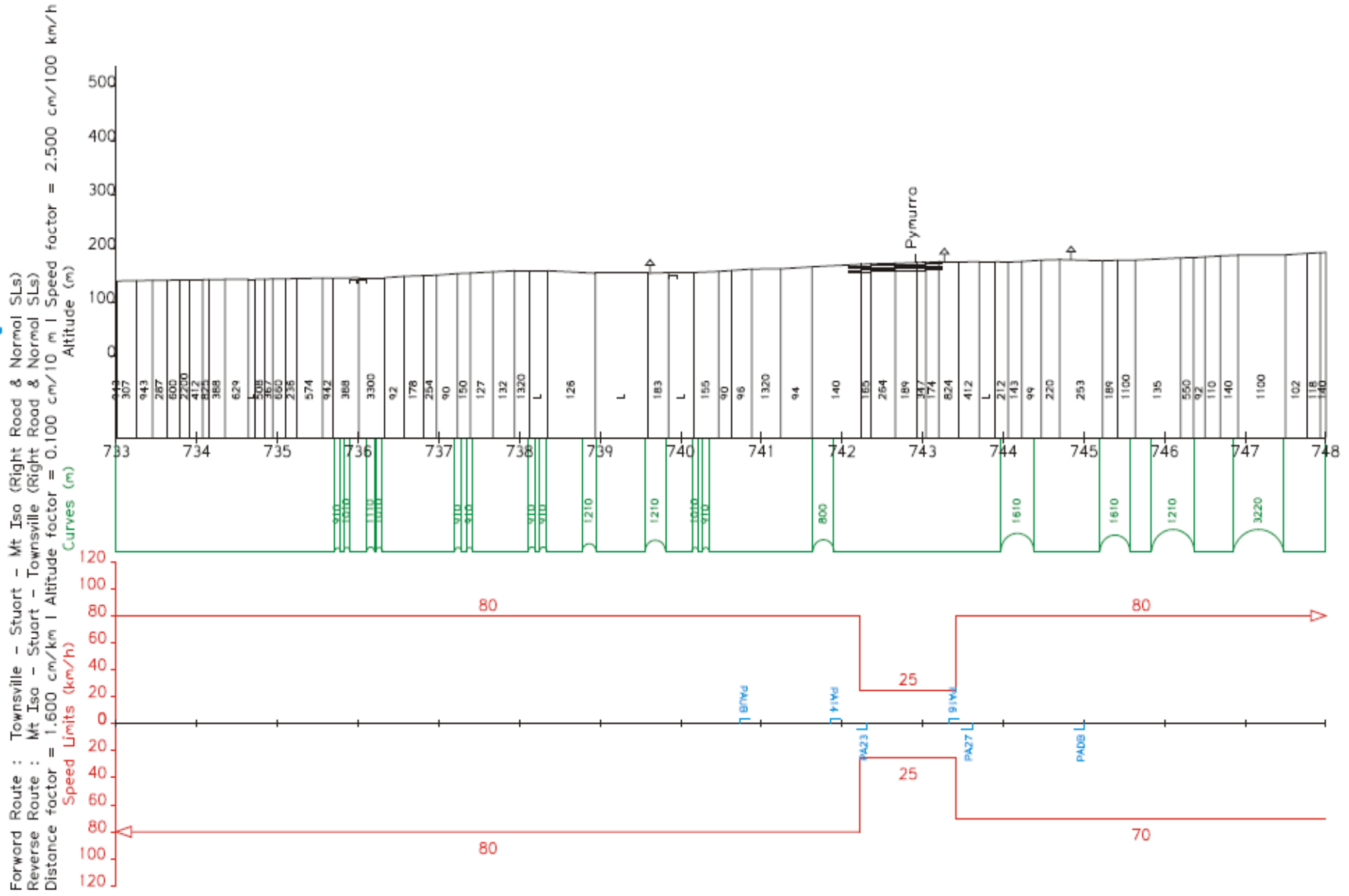



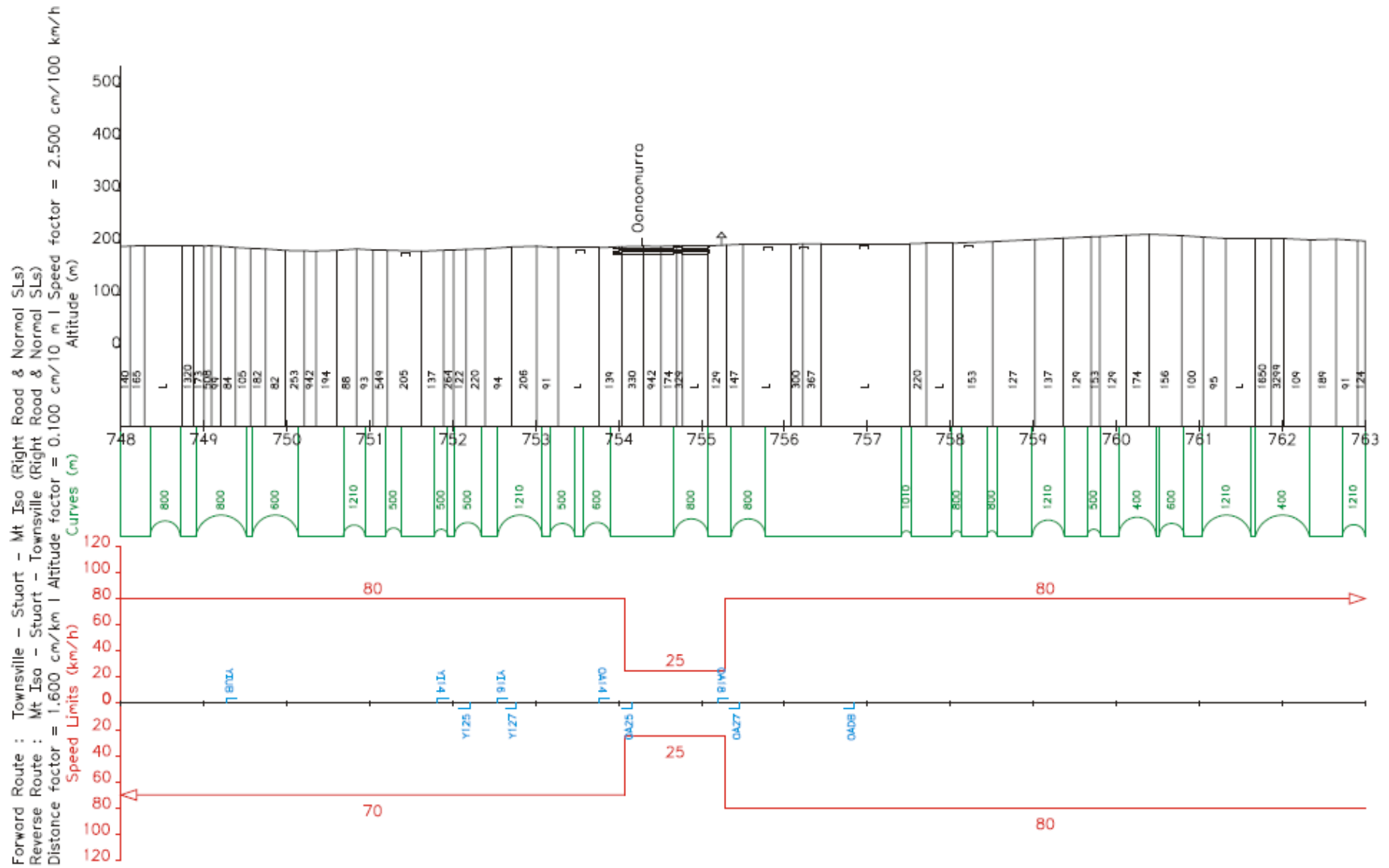

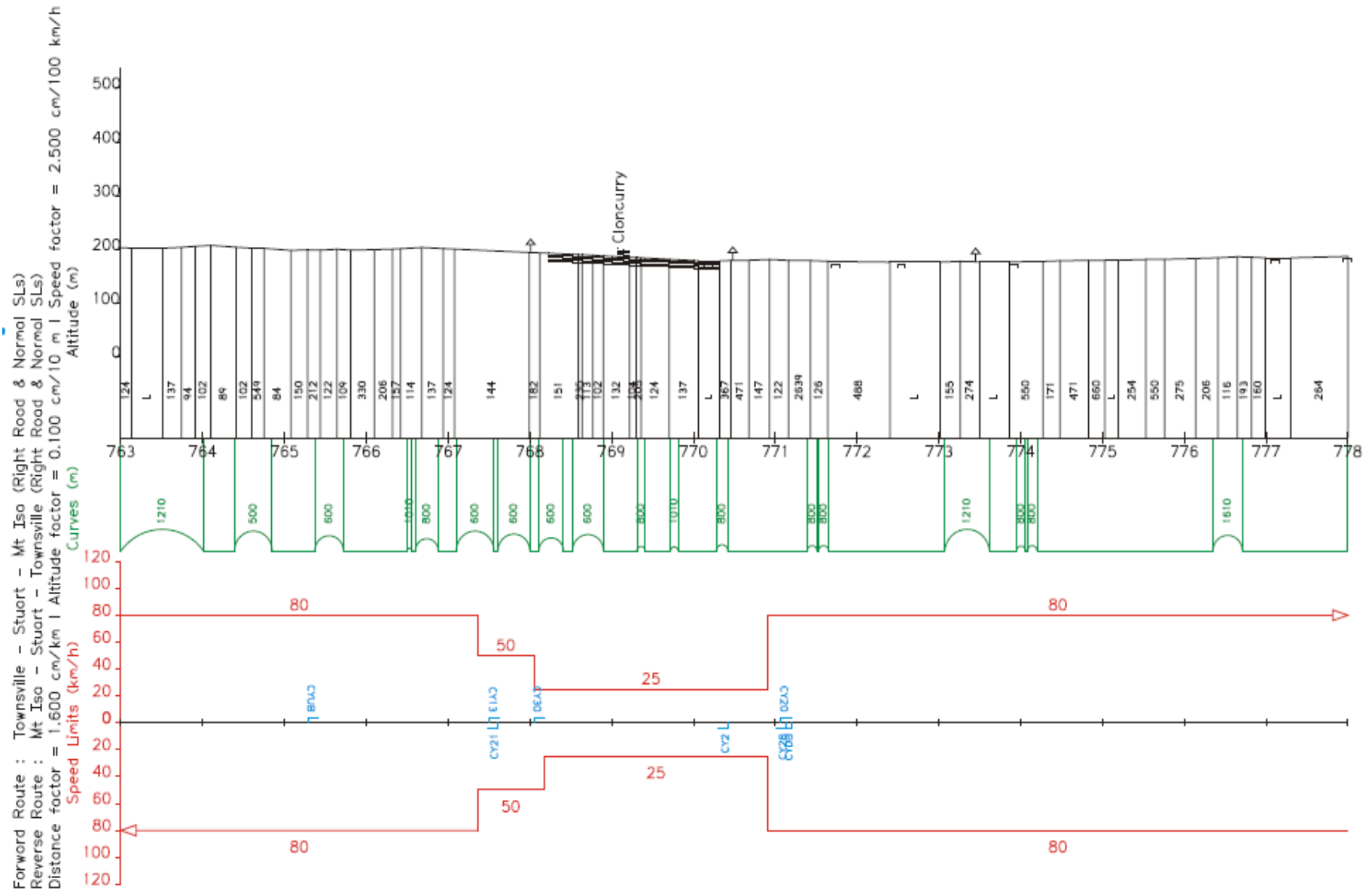

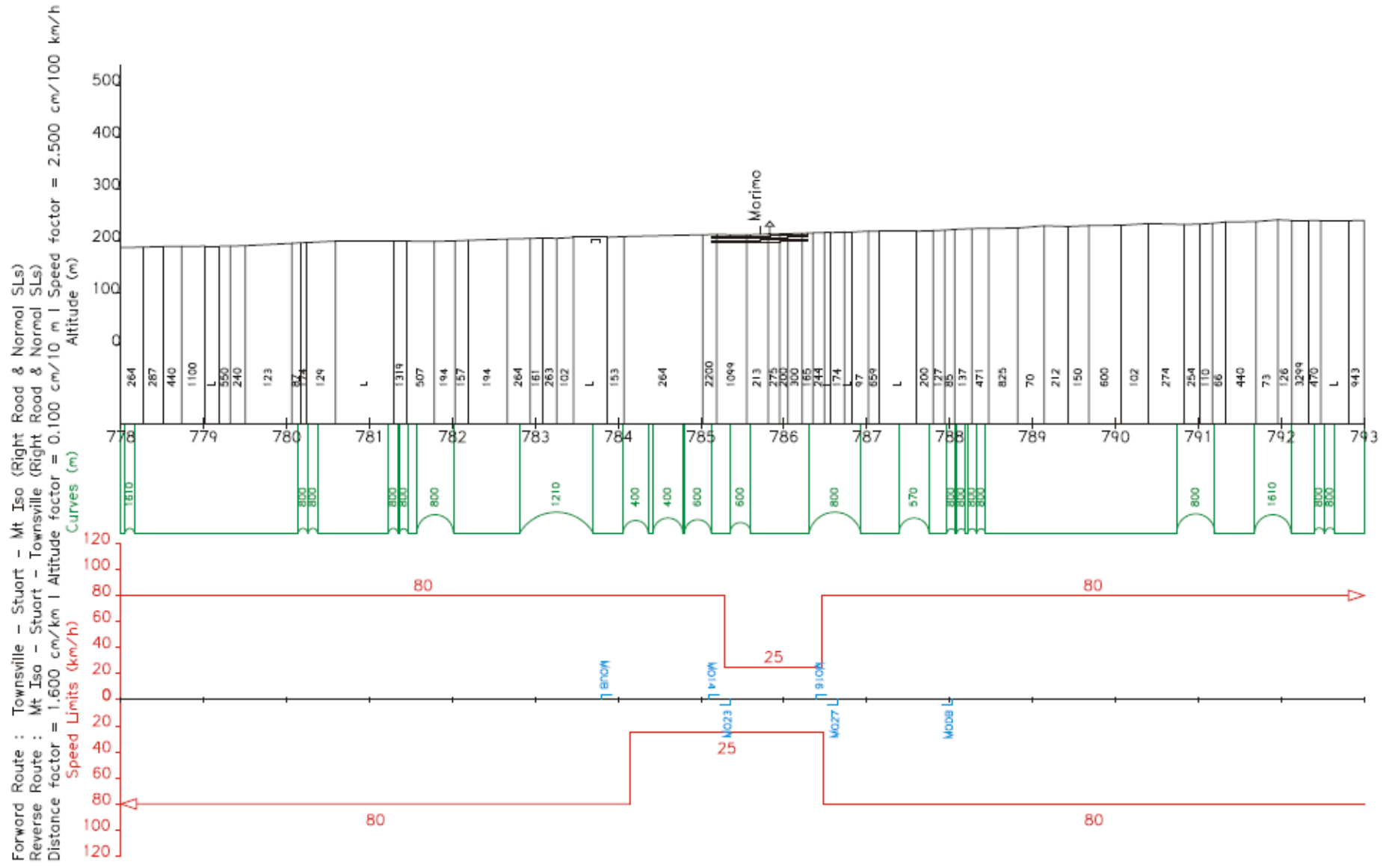

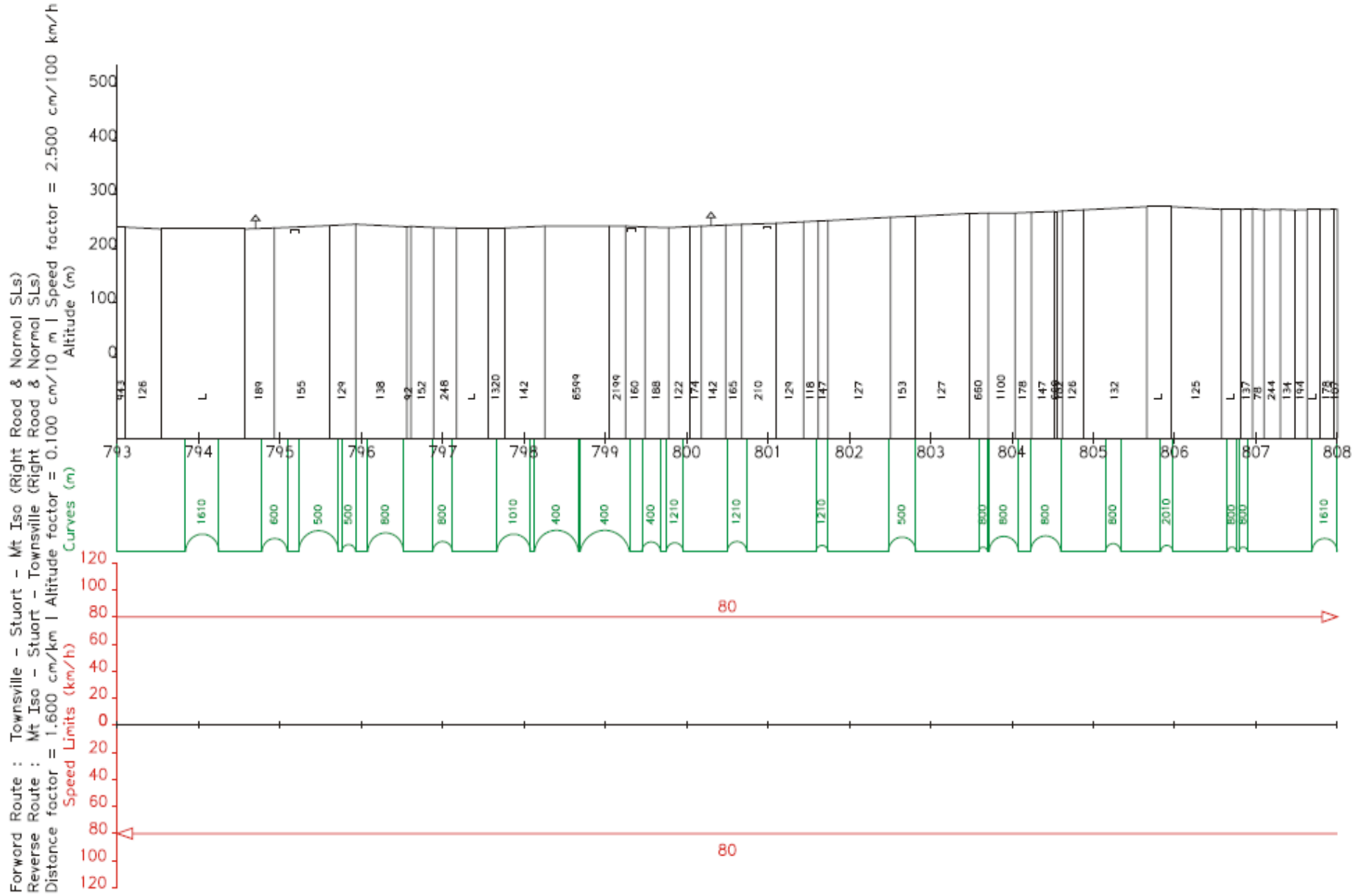

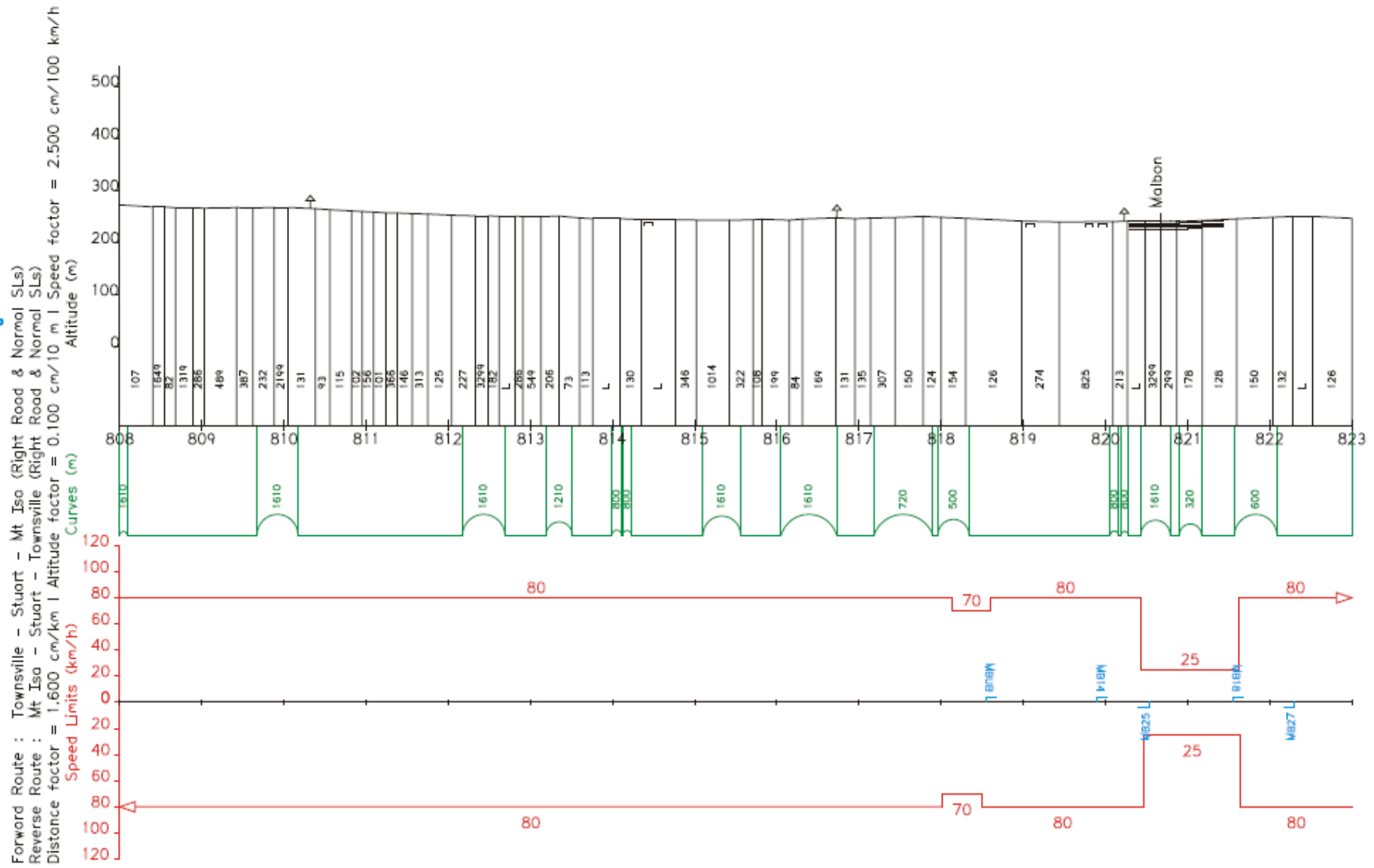

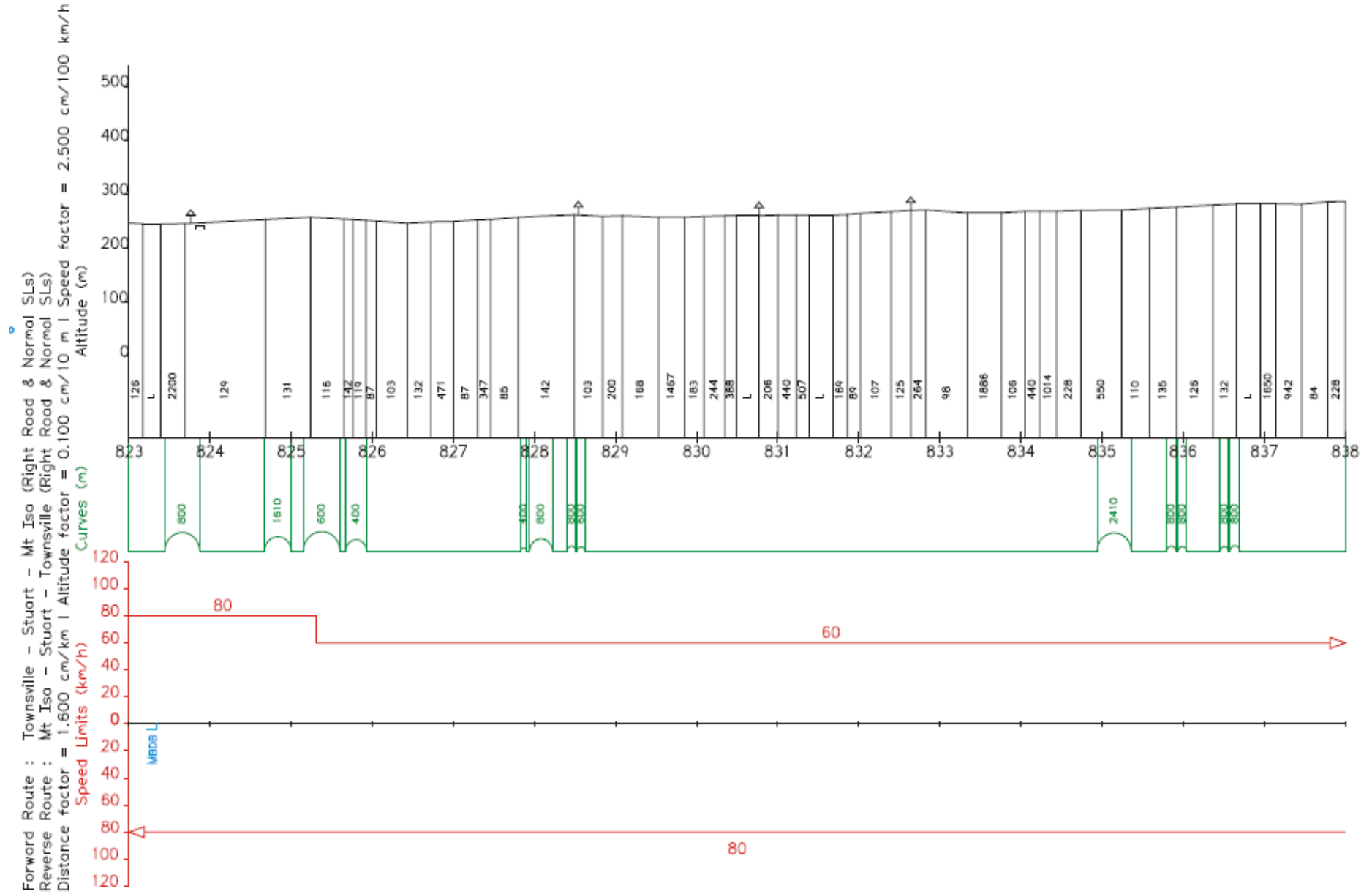

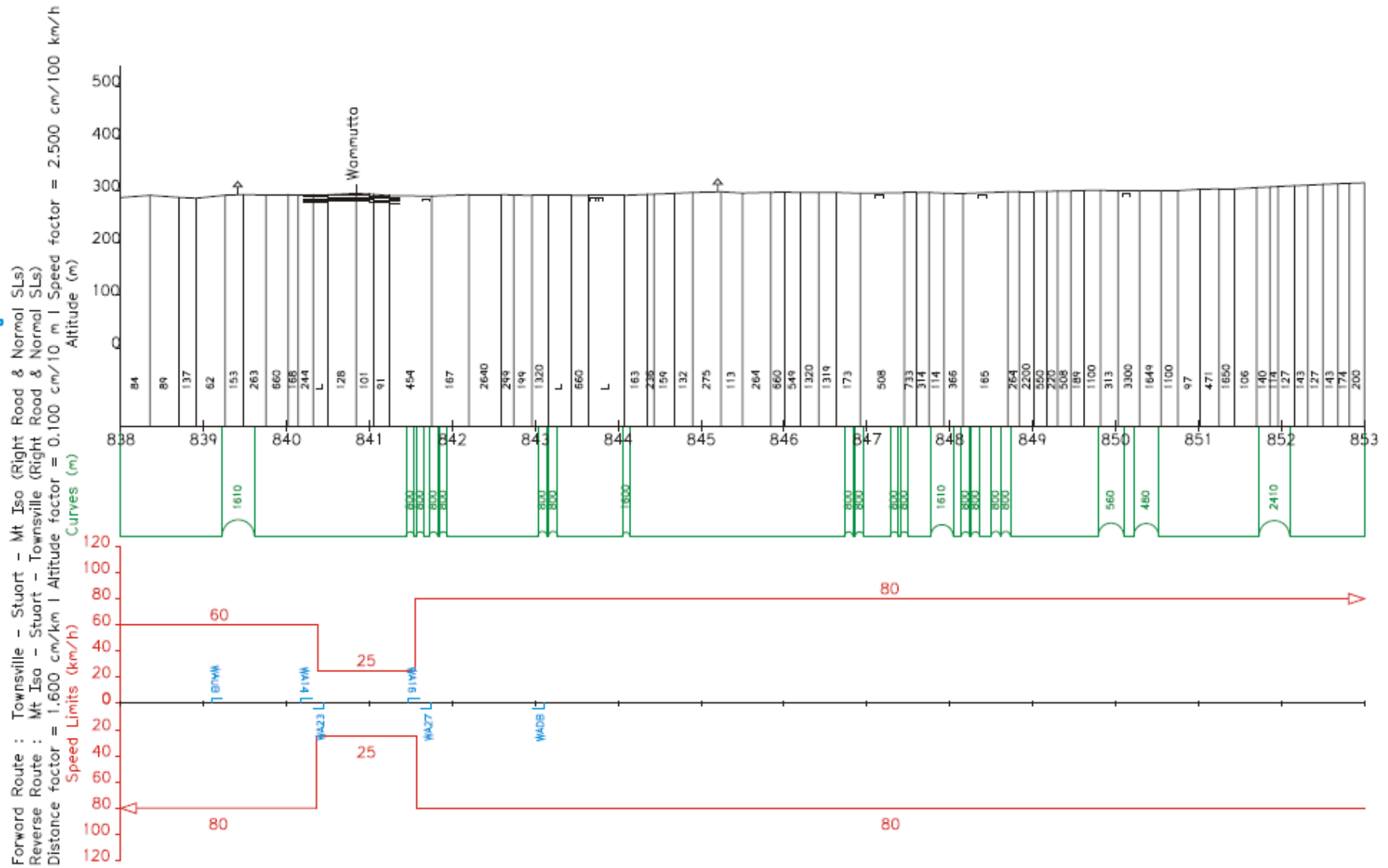

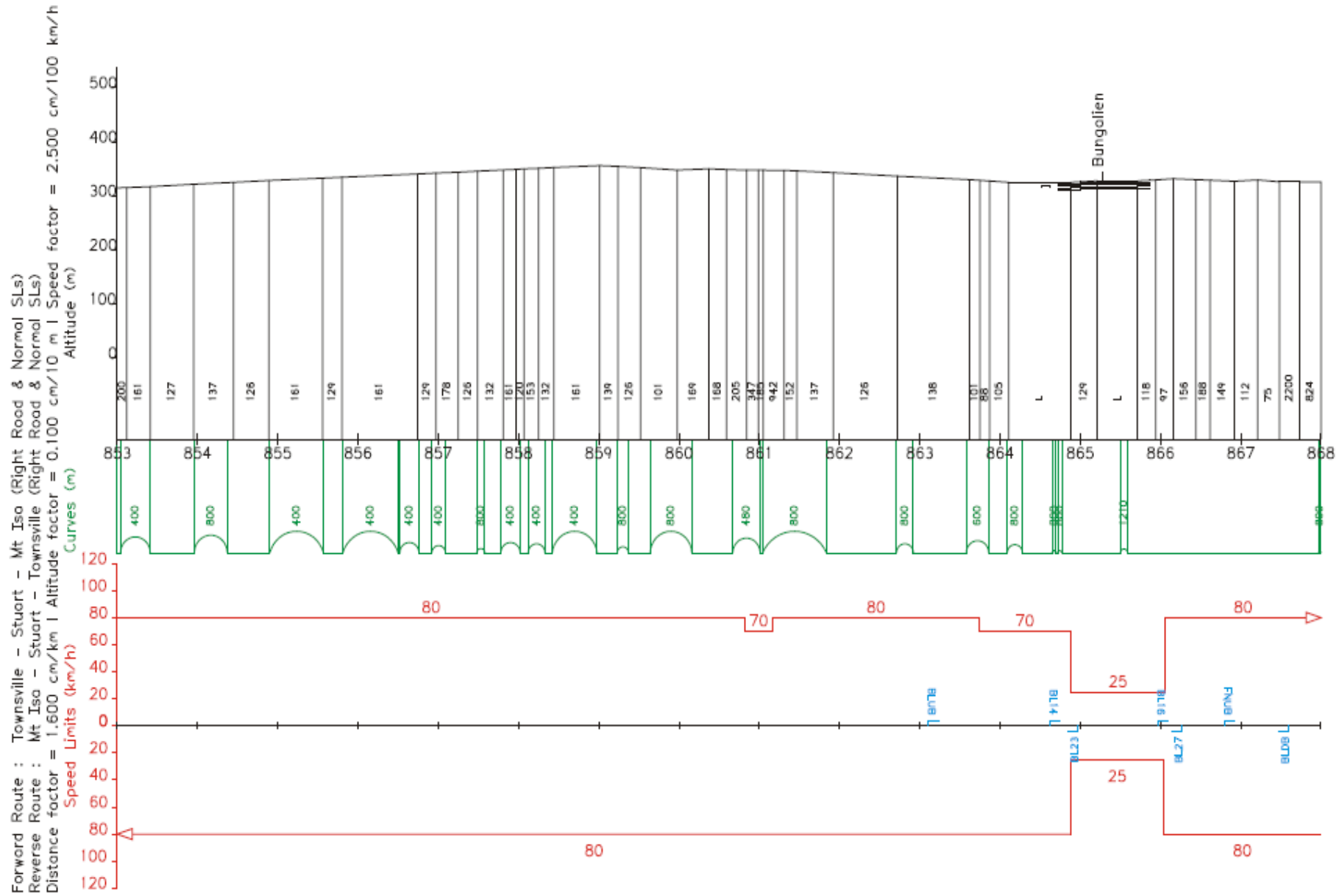



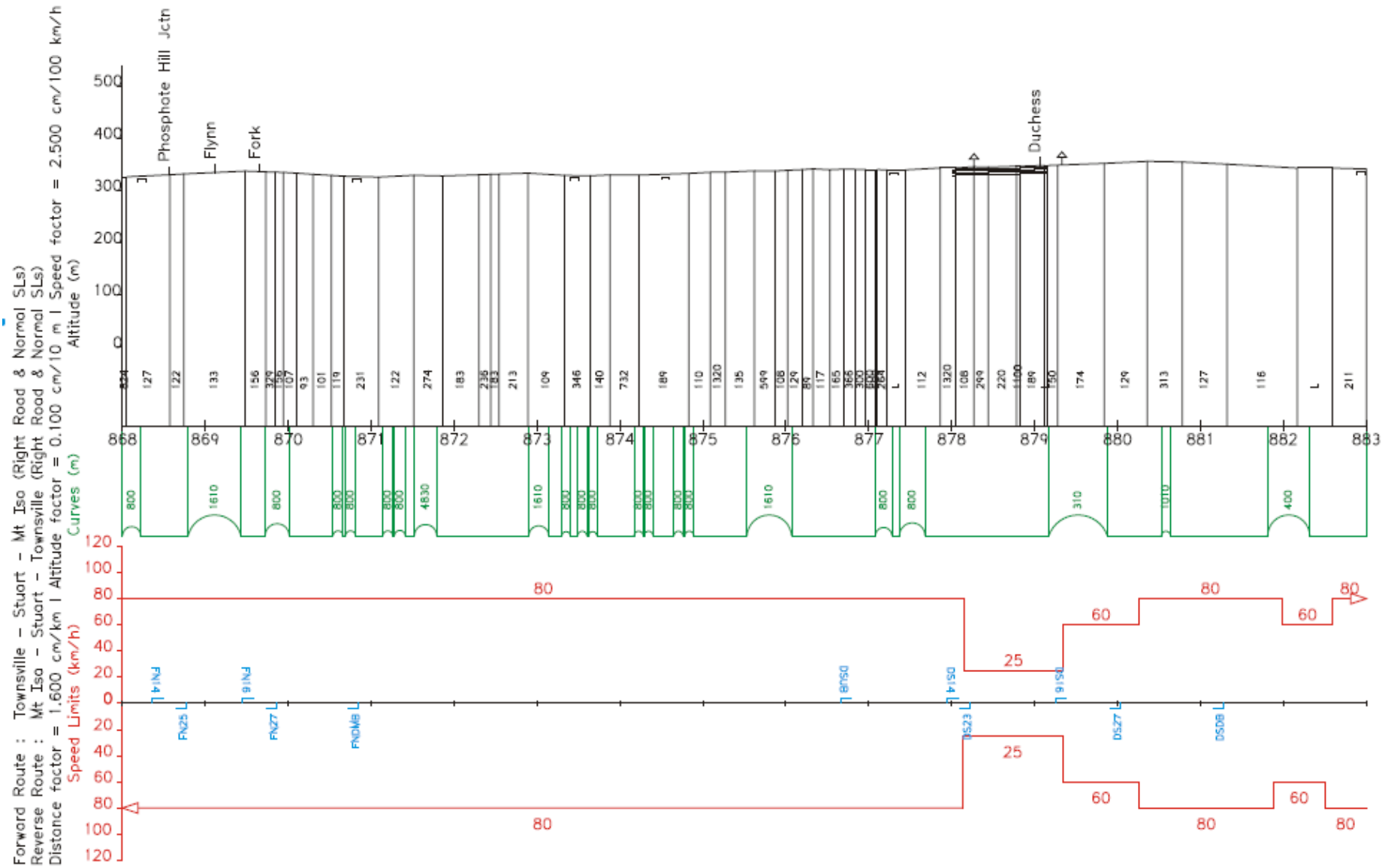

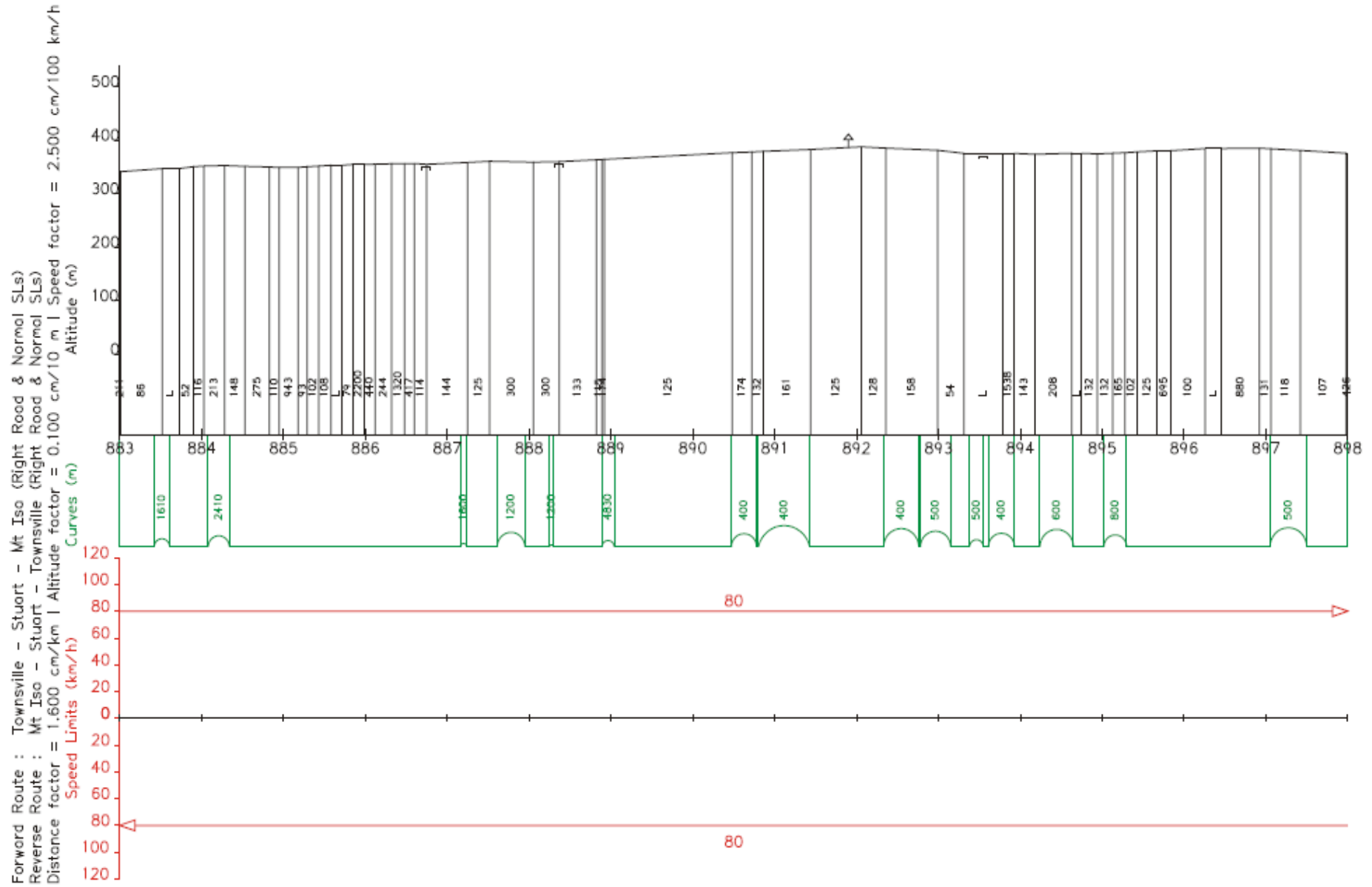

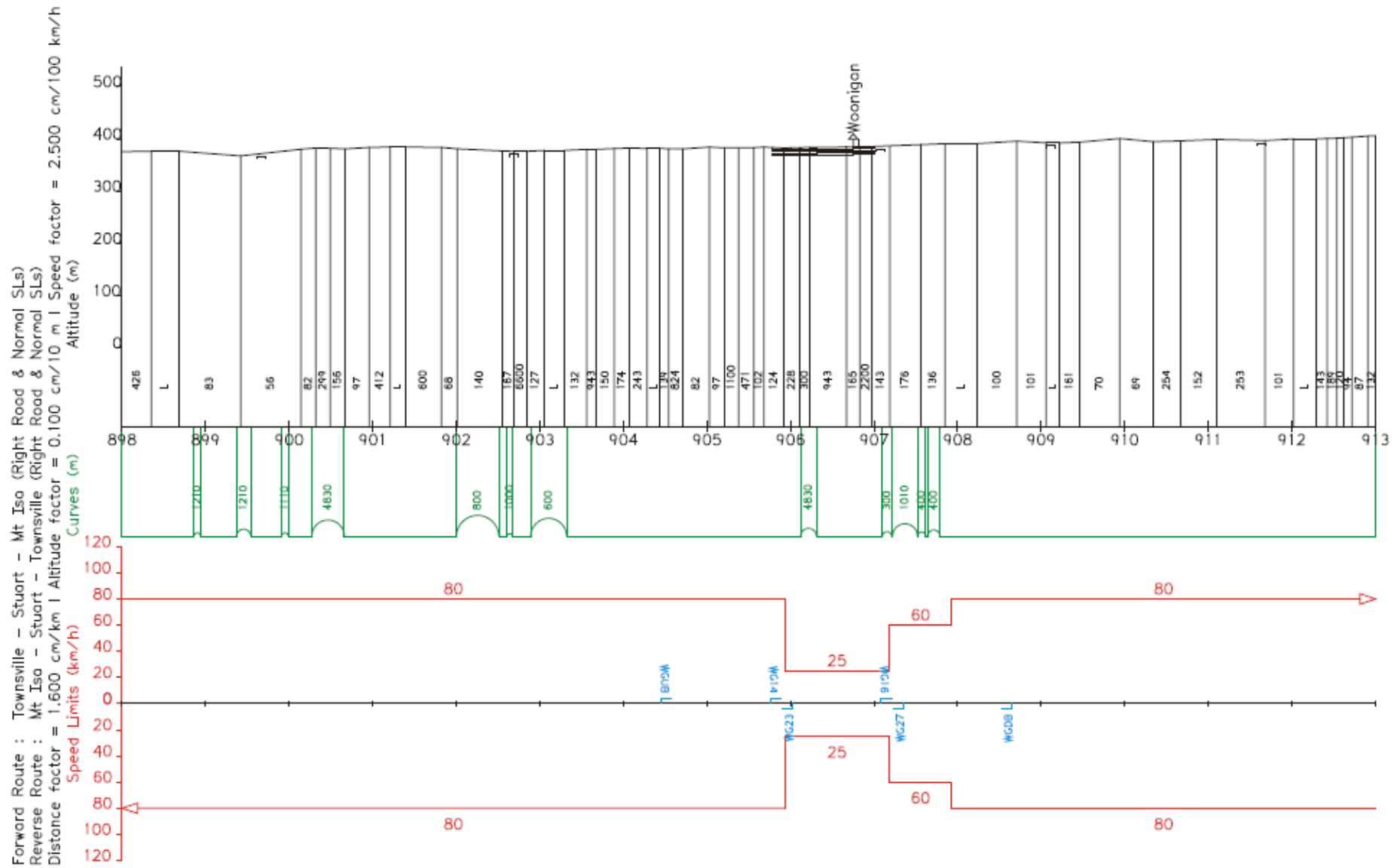

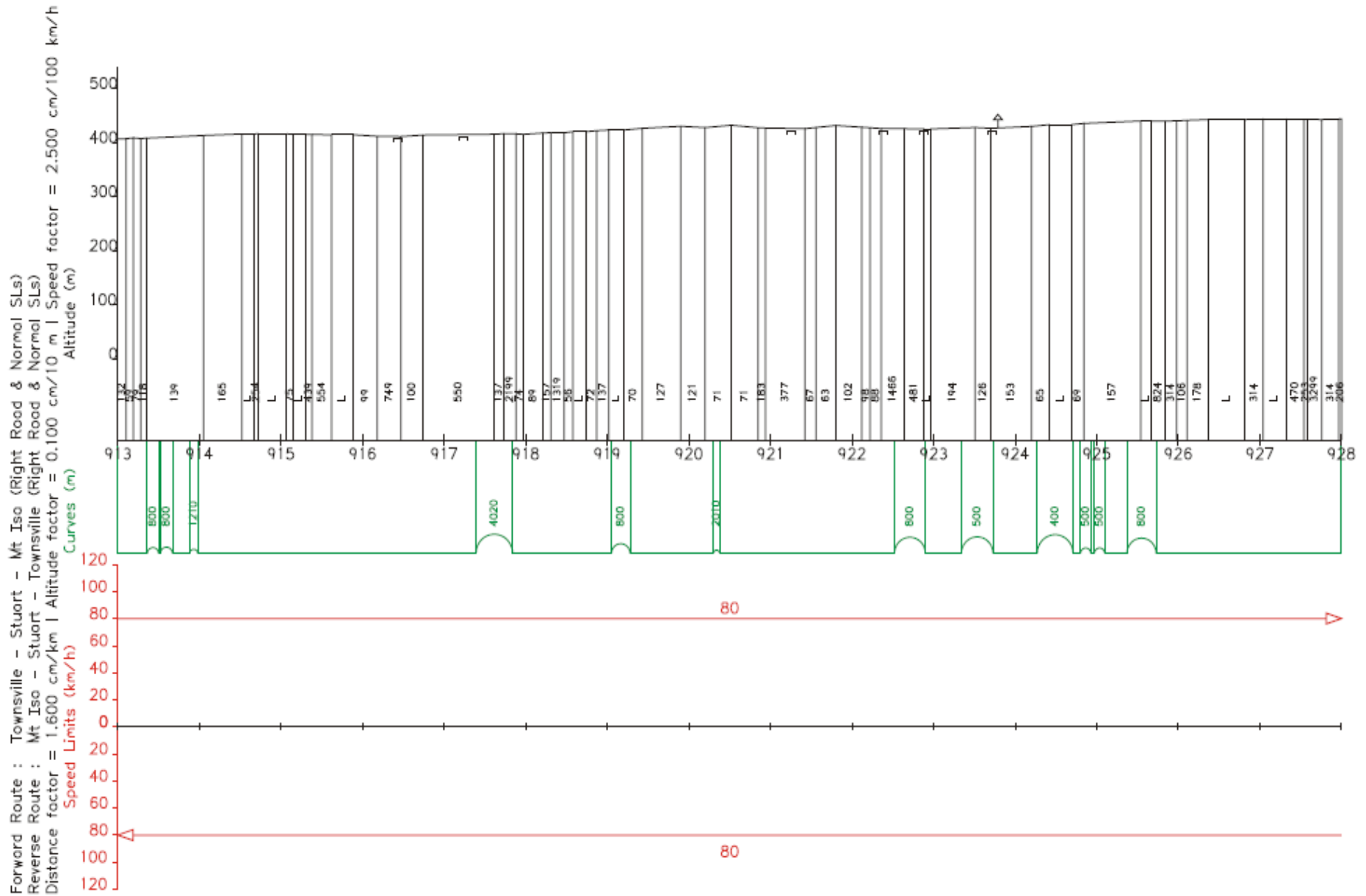

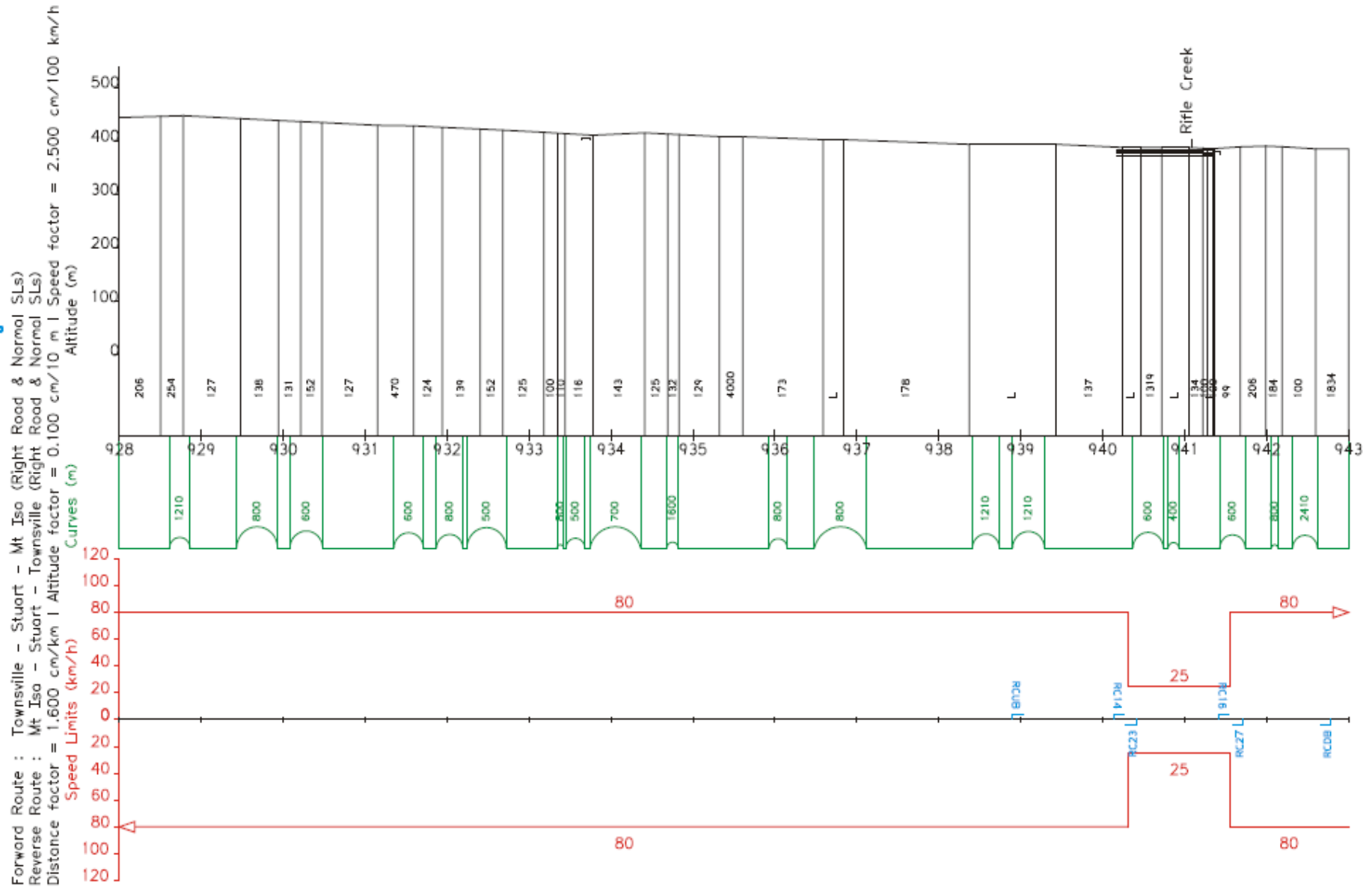

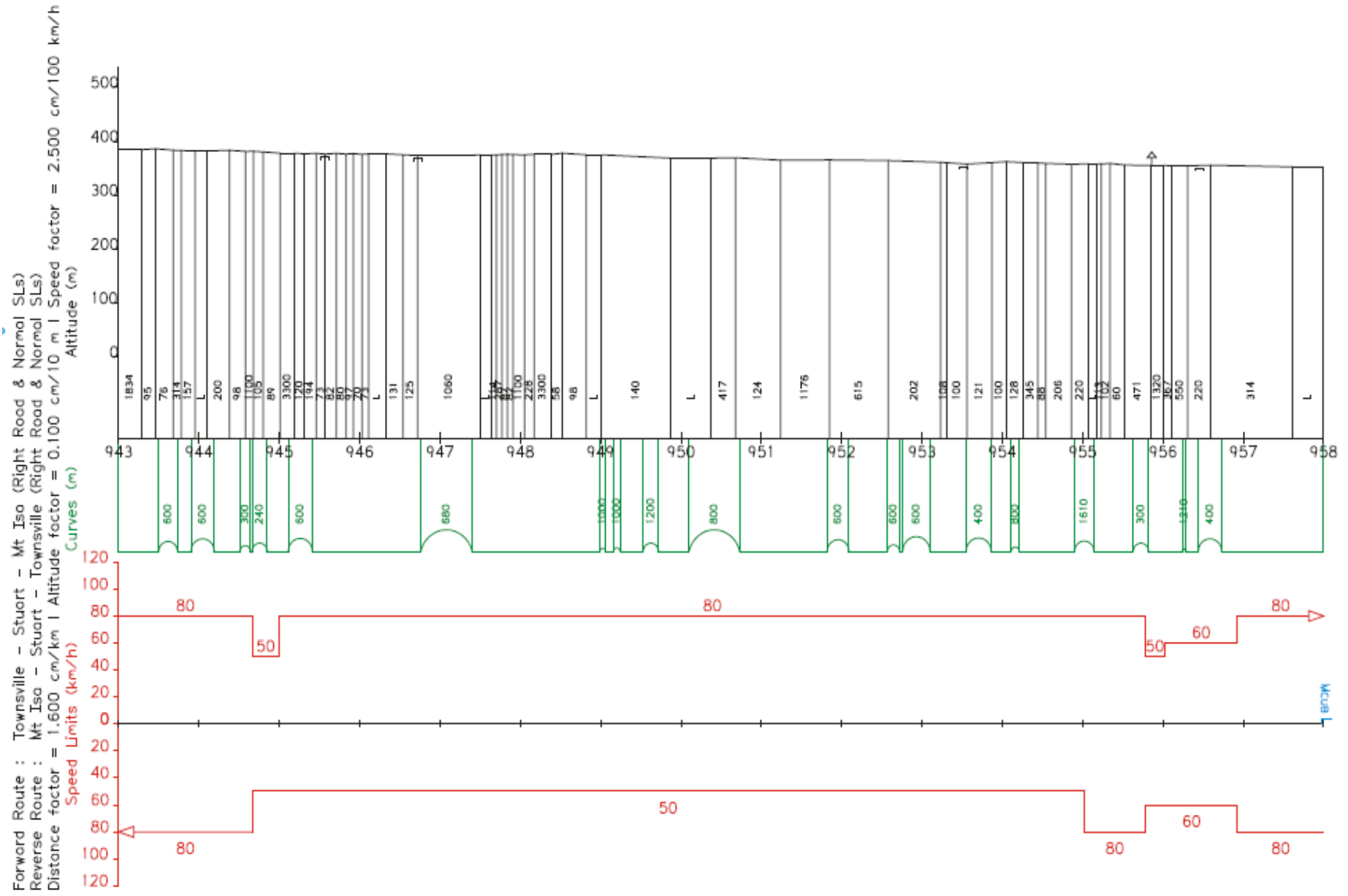

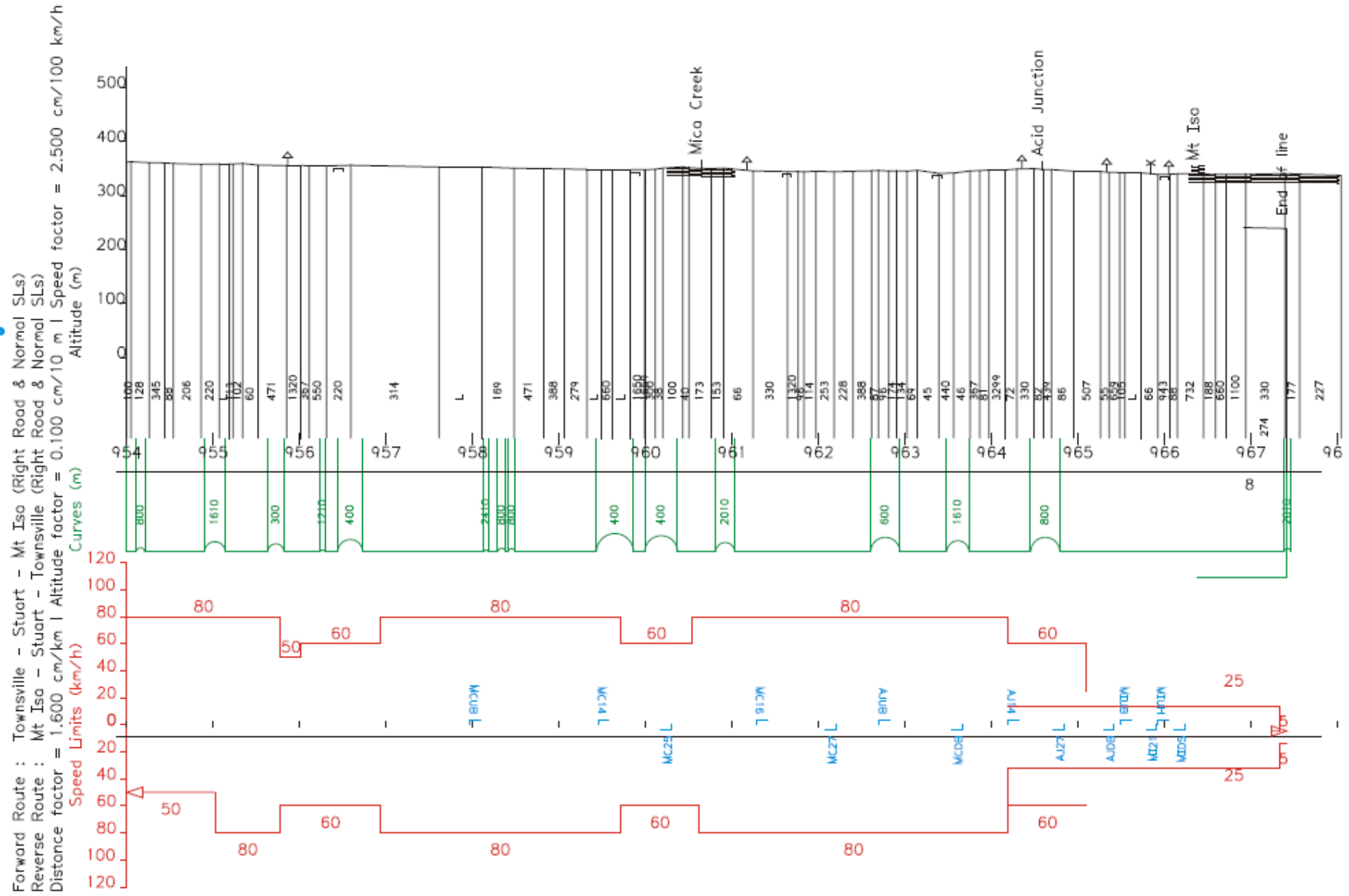

Queensland Rail does not warrant the fitness for purpose or accuracy of this information.

Mount Isa Line  
Information Pack

## APPENDIX F Sectional Running Times

SECTION	UP	DOWN
Townsville Jetty > Stuart	28	24
Stuart > Antill Plains	18	15
Antill Plains > Woodstock	22	18
Woodstock > Reid River	21	22
Reid River > Woldston	14	13
Woldston > Mingela	41	29
Mingela > Sellheim	34	37
Sellheim > Ch. Towers	30	27
Ch. Towers > Southern Cross	25	25
Southern Cross > Balfes Ck	26	28
Balfes Ck > Mungunburra	21	21
Mungunburra > Thalanga	9	7
Thalanga > Homestead	16	13
Homestead > Pentland	42	40
Pentland > Warrigal	24	28
Warrigal > Burra	25	18
Burra > Torrens Ck	21	25
Torrens Ck > Warreah	25	23
Warreah > Prairie	25	23
Prairie > Tindo	25	27
Tindo > Hughenden	43	39
Hughenden > Boree	33	37
Boree > Mumu	33	35
Mumu > Marathon	36	30
Marathon > Barabon	21	19
Barabon > Moselle	18	17
Moselle > Richmond	29	47
Richmond > Gemoka	35	36
Gemoka > Maxwelton	34	33
Maxwelton > Nonda	28	26
Nonda > Nelia	40	46
Nelia > Quarrells	32	29
Quarrells > Julia Ck	34	31
Julia Ck > Gilliat	39	39
Gilliat > Tibarri	28	26
Tibarri > Oorindi	31	30
Oorindi > Undina	22	19
Undina > Pymurra	23	21



Queensland Rail does not warrant the fitness for purpose or accuracy of this information.

Mount Isa Line  
Information Pack

<b>SECTION</b>	<b>UP</b>	<b>DOWN</b>
Pymurra > Cannington Jcn	14	13
Cannington Jcn > Oonoomurra	7	6
Oonoomurra > Cloncurry	25	21
Cloncurry > Marimo	24	26
Marimo > Malbon	45	44
Malbon > Wammutta	27	29
Wammutta > Bungalien	31	31
Bungalien > Flynn	11	10
Flynn > Duchess	16	12
Duchess > Woonigan	36	34
Woonigan > Rifle Ck	42	41
Rifle Ck > Mt Isa	44	38

**Queensland Rail does not warrant the fitness for purpose or accuracy of this information.**

Mount Isa Line  
Information Pack

# APPENDIX G Rollingstock Outlines

Reference Rolling Stock Outline RS1

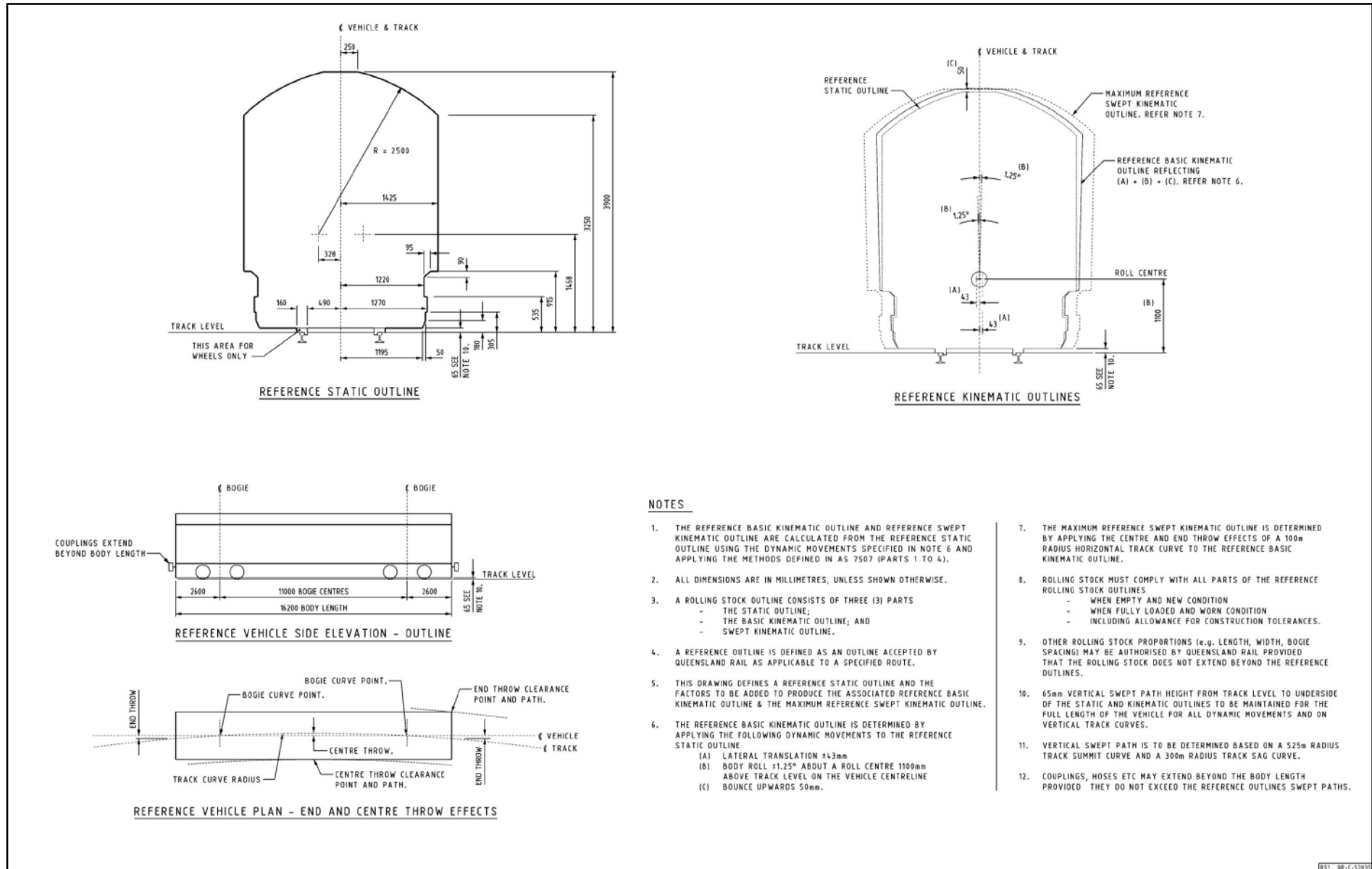

### Reference Rolling Stock Outline RS2

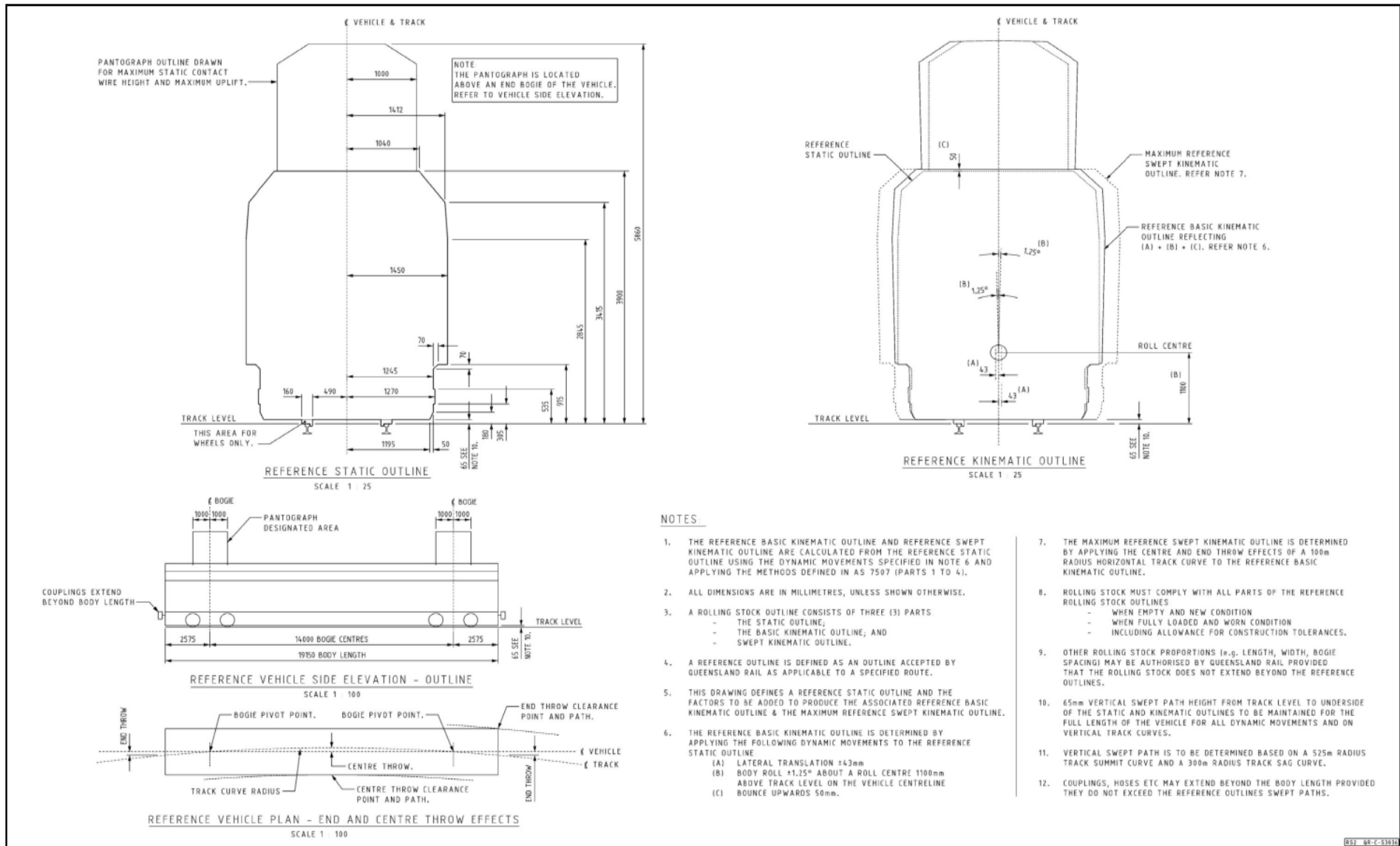

Reference Rolling Stock Outline RS3

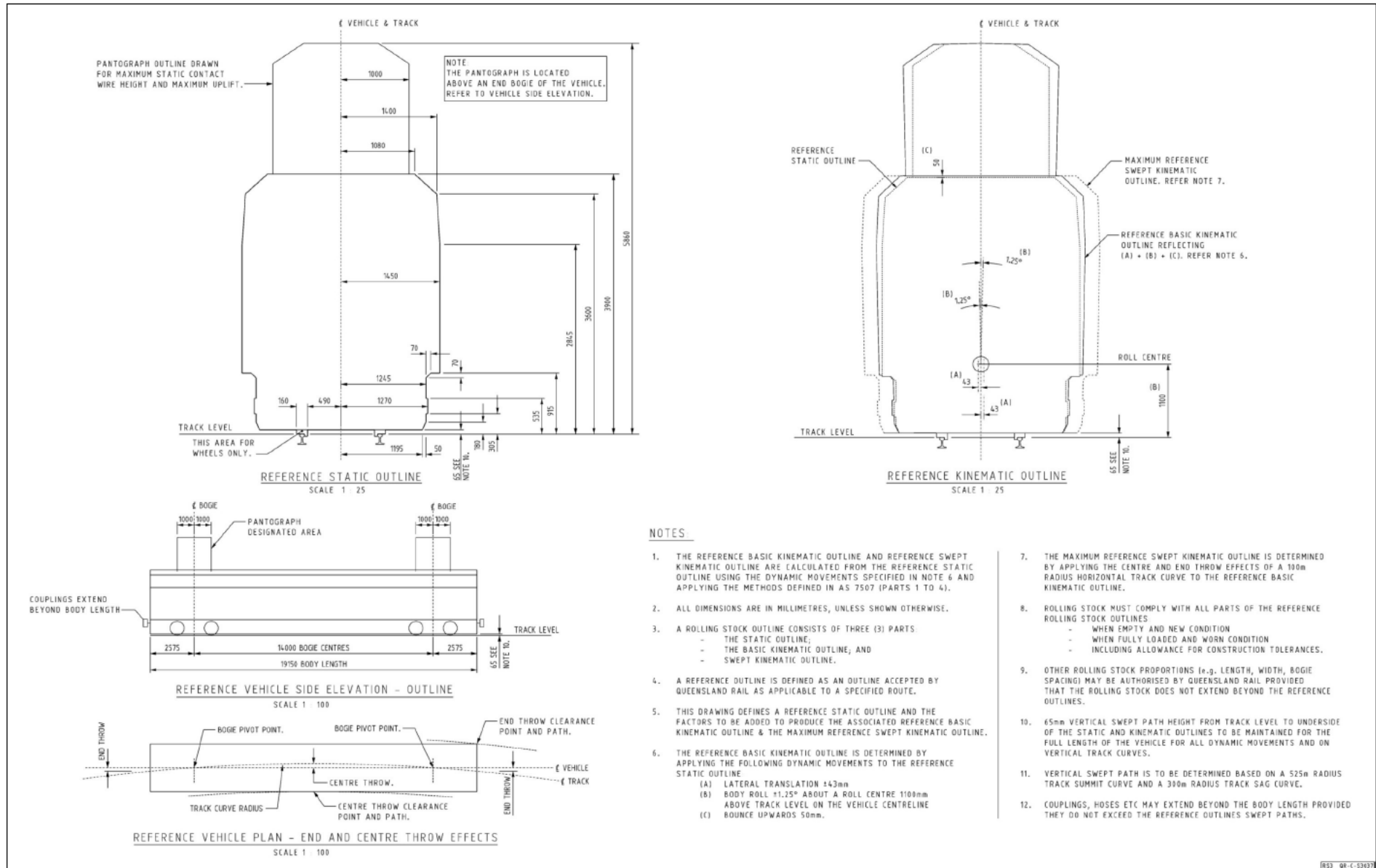

Reference Rolling Stock Outline RS4

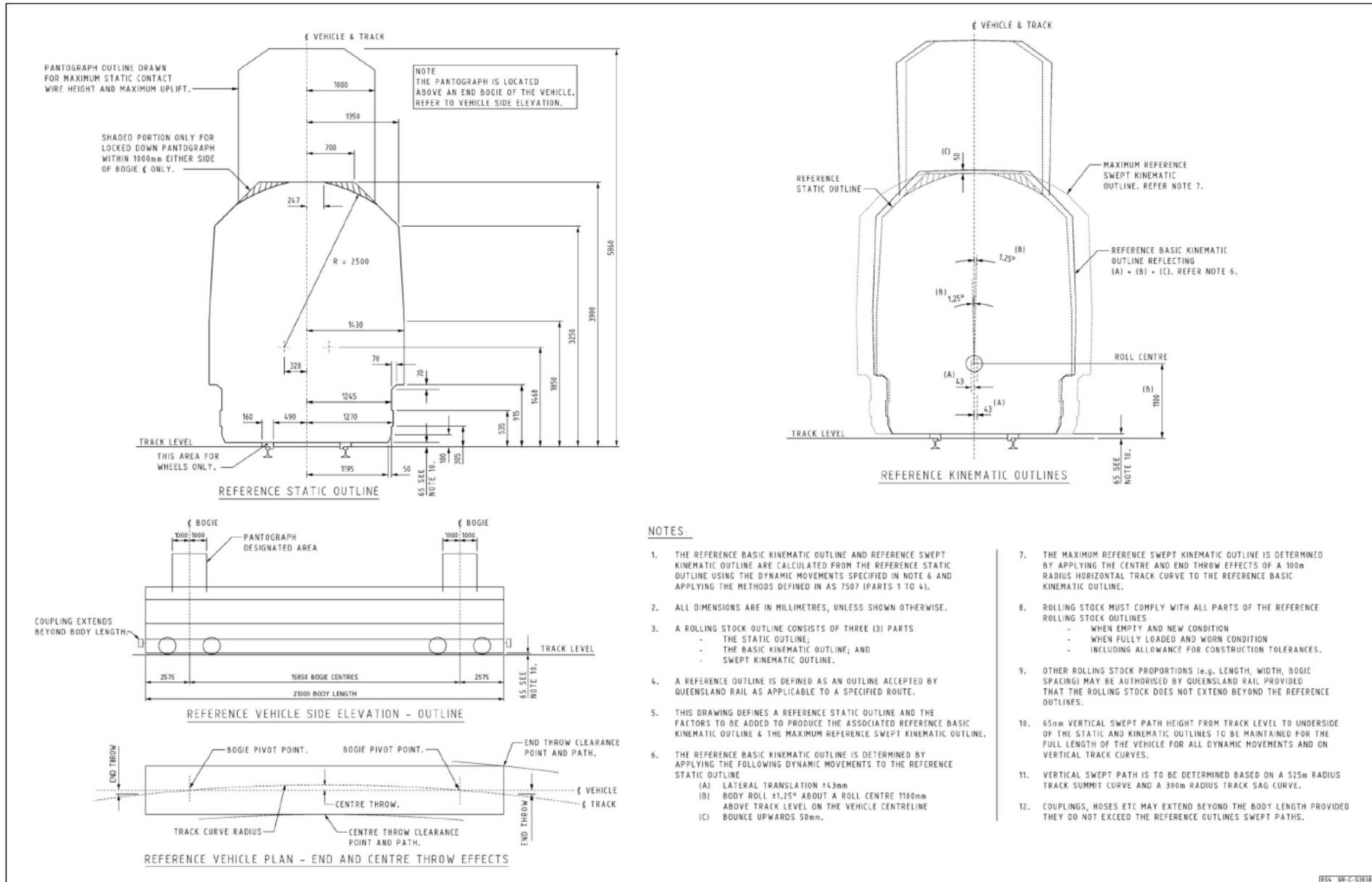

NOTES:

1. THE REFERENCE BASIC KINEMATIC OUTLINE AND REFERENCE SWEEP KINEMATIC OUTLINE ARE CALCULATED FROM THE REFERENCE STATIC OUTLINE USING THE DYNAMIC MOVEMENTS SPECIFIED IN NOTE 6 AND APPLYING THE METHODS DEFINED IN AS 7507 (PARTS 1 TO 4).
2. ALL DIMENSIONS ARE IN MILLIMETRES, UNLESS SHOWN OTHERWISE.
3. A ROLLING STOCK OUTLINE CONSISTS OF THREE (3) PARTS
  - THE STATIC OUTLINE;
  - THE BASIC KINEMATIC OUTLINE; AND
  - SWEEP KINEMATIC OUTLINE.
4. A REFERENCE OUTLINE IS DEFINED AS AN OUTLINE ACCEPTED BY QUEENSLAND RAIL AS APPLICABLE TO A SPECIFIED ROUTE.
5. THIS DRAWING DEFINES A REFERENCE STATIC OUTLINE AND THE FACTORS TO BE ADDED TO PRODUCE THE ASSOCIATED REFERENCE BASIC KINEMATIC OUTLINE & THE MAXIMUM REFERENCE SWEEP KINEMATIC OUTLINE.
6. THE REFERENCE BASIC KINEMATIC OUTLINE IS DETERMINED BY APPLYING THE FOLLOWING DYNAMIC MOVEMENTS TO THE REFERENCE STATIC OUTLINE
  - (A) LATERAL TRANSLATION ±43mm
  - (B) BODY ROLL ±1.25° ABOUT A ROLL CENTRE 1100mm ABOVE TRACK LEVEL ON THE VEHICLE CENTRELINE
  - (C) BOUNCE UPWARDS 50mm.
7. THE MAXIMUM REFERENCE SWEEP KINEMATIC OUTLINE IS DETERMINED BY APPLYING THE CENTRE AND END THROW EFFECTS OF A 100m RADIUS HORIZONTAL TRACK CURVE TO THE REFERENCE BASIC KINEMATIC OUTLINE.
8. ROLLING STOCK MUST COMPLY WITH ALL PARTS OF THE REFERENCE ROLLING STOCK OUTLINES
  - WHEN EMPTY AND NEW CONDITION
  - WHEN FULLY LOADED AND WORN CONDITION
  - INCLUDING ALLOWANCE FOR CONSTRUCTION TOLERANCES.
9. OTHER ROLLING STOCK PROPORTIONS (e.g. LENGTH, WIDTH, BOGIE SPACING) MAY BE AUTHORISED BY QUEENSLAND RAIL PROVIDED THAT THE ROLLING STOCK DOES NOT EXTEND BEYOND THE REFERENCE OUTLINES.
10. 65mm VERTICAL SWEEP PATH HEIGHT FROM TRACK LEVEL TO UNDERSIDE OF THE STATIC AND KINEMATIC OUTLINES TO BE MAINTAINED FOR THE FULL LENGTH OF THE VEHICLE FOR ALL DYNAMIC MOVEMENTS AND ON VERTICAL TRACK CURVES.
11. VERTICAL SWEEP PATH IS TO BE DETERMINED BASED ON A 525m RADIUS TRACK SUMMIT CURVE AND A 300m RADIUS TRACK SAG CURVE.
12. COUPLINGS, NOSES ETC MAY EXTEND BEYOND THE BODY LENGTH PROVIDED THEY DO NOT EXCEED THE REFERENCE OUTLINES SWEEP PATHS.